



WAMAK

Wärmepumpe



TBW 85 EVI

ARB-WAMAK TBW 85 EVI

Beschreibung des Produkts

Wärmepumpe mit zwei Leistungsstufen für Heizung und Warmwasser mit der Möglichkeit einer passiven Kühlregelung. Ein kurzer geschlossener Kältemittelkreislauf mit zwei leisen Scroll-Verdichtern und robusten Plattenwärmetauschern aus Edelstahl. Mit dem Anschlusskit können die Umwälzpumpen einfach und schnell angeschlossen werden, während ihre variable Drehzahl extern gesteuert wird.

Verwendung für Mehrfamilienhäuser, gemischt genutzte Vorstadtgebäude oder Gewerbebetriebe. Die URBAN-Reihe basiert auf einer robusten Konstruktion gefertigt aus hochwertigem Stahl. Hochwertige, langjährig bewährte Komponenten des Wärmepumpenkreislaufs verlängern die Lebensdauer der Wärmepumpe.

Als primäre Quelle wird die im Boden gespeicherte thermische Energie der Sonne über einen horizontalen Kollektor oder die geothermische Energie über ein tiefes Bohrloch genutzt. Im Kollektor oder in der Bohrung fließt ein Frostschutzmittel, das die Energie des Erdreichs bei einer niedrigen Temperatur aufnimmt, und die Wärmepumpe hebt diese Temperatur auf eine für Heizung oder Warmwasser nutzbare Temperatur an.

Die EVI-Technologie (Enhanced Vapour Injection) ermöglicht es der Wärmepumpe, auch bei niedrigen Quelltemperaturen höhere Heizungswasser Vorlauftemperaturen zu erreichen. EVI wirkt sich auch auf die Lebensdauer des Kompressors und des gesamten Systems aus, da die Heissgastemperatur des Verdichters niedriger ist.

Die Doppelverdichter verleihen dem System Robustheit und die Fähigkeit, die Wärmeleistung entsprechend der tatsächlichen Belastung zu verteilen.

Produkt Besonderheiten

- Scroll Verdichter
- EVI Technologie
- Asymetrischer Platten- Wärmetauscher
- Mehrstufige Leistungsregelung
- Hochdruck Schalter
- Niederdruck Sensor - analog
- Durchflusssensor Abgabe - analog - (mit Zubehör)
- Regelung von gemischtem Heiz/Kuhl- Kreis
- Steuerung von BWW Umschaltung
- Außentemperaturfühler - (mit Zubehör)
- Puffer Temperaturfühler - (mit Zubehör)
- Modbus Anschluss - (mit Zubehör)
- Sylomer pads unter Verdichter
- Elektronischer Expansionsventil
- Zweistufige Leistungsregelung
- Phasen- und Drehfeldüberwachung
- Hochdruck Sensor - analog
- Durchflussschalter Abgabe - Ein/Aus - (mit Zubehör)
- Durchflussschalter Quelle - Ein/Aus - (mit Zubehör)
- Regelung von direktem Heiz/Kuhl- Kreis
- Steuerung von BWW Zirkulation
- BWW Temperaturfühler - (mit Zubehör)
- Kasladesteuerung - (mit Zubehör)
- Massiver Unterstellrahmen

Grundlegende Leistungsdaten - ARB-WAMAK TBW 85 EVI

Heizen - EN 14511		
Wärmeleistung [kW]	B0 / W35 (max)	83.4 (41.7 / 83.4)
	B0 / W35 (min)	41.7 (41.7 / 83.4)
	B0 / W34	83.4 (41.7 / 83.4)
Leistungsaufnahme [kW]	B0 / W35 (max)	18.7 (9.2 / 18.7)
	B0 / W35 (min)	9.2 (9.2 / 18.7)
	B0 / W34	18.3 (9.0 / 18.3)
Leistungszahl Heizen [COP]	B0 / W35 (max)	4.46
	B0 / W35 (min)	4.53
	B0 / W34	4.56
Jahreszeitbedingte Raumheizungs-Energieeffizienz - SCOP EN 14825		
Klimazone Durchschnitt / Niedrigtemp. [35°C]	SCOP	5.02
	η [%]	200.9
	Label	A+++
	Qhe [kWh]	172304.4
	Pdesignh [kW]	83.4
	Tbivalent [°C]	-10
Kühlung		
Kühlleistung - [kW]	A35 / W23-18	85.3
	A25 / W23-18	89.7
	A35 / W12-7	85.3
	A25 / W12-7	85.3
Jahreszeitbedingte Raumkühlungs-Energieeffizienz - SEER EN 14825		
[W 23 / 18°C]	SEER	5.23
	Qce [kWh]	37740.0
	η_c [%]	209.2
Schall EN 12102		
Schalleistungspegel - Lw	dB(A)	64.5
Schalldruckpegel - Lp	1 m dB(A)	56.5
	5 m dB(A)	42.5
	10 m dB(A)	36.5
Mechanische und Betriebs-Informationen		
Verdichterbauart (3~ 400/50)	SCROLL / 2 /	Ein/Aus
Kältemittel	R410A (GWP - 2088)	10.6 kg
Einsatzgrenze Heizungswasser - (min / max) [°C]		25 / 65
Einsatzgrenze Wärmequelle - (min / max) [°C]		-10 (7) / 30
Gewicht		445 kg

Wichtigste technische Daten - ARB-WAMAK TBW 85 EVI

Gehäuse Bezeichnung			VN1100			Daten von Wärmeabgabe			
Grundlegende Abmessungen	Hohe [mm]	1270	Einsatzgrenze	MAX [°C]	65	genauer siehe Betriebsgrenzendiagramm			
	Breite [mm]	1100	Heizungswasser	MIN [°C]	25				
	Länge [mm]	750	Kondensator			Anschlussdimension	VIC 2.1/2 "		
Gewicht [kg]	445				Bauart	BPHE			
Gehäuse Farbe	Grau					Anzahl	1		
Gehäuse IP Klasse	IP20					Material	AISI 316		
Kältekreis						Maximaler Überdruck - Kältemittel [bar]			50
Verdichter	Bauart	Scroll				Maximaler Überdruck - Wasser [bar]			6
	Leistungsstufen	2				Prüfdruck [bar]			70
	Ein/Aus					Wärmeträger			Wasser
	Leistungsfaktor Cosφ	0.59				Volumenstrom @ dT 5K (nom) - Wasser [m3/h]			7.21 ~ 14.41
	Wicklungswiderstand	0.83 Ohm				Interne Druckdifferenz - Wasser [kPa]			20
Kältemittel		R410A				Temperaturdifferenz @ 35°C (nom)			5 K
	Menge	10.6 kg				@ 55°C			8 K
	GWP	2088				@ 65°C			10 K
	Sicherheitsklasse	A1							
Kältemittelöl	POE RL32-3MAF				Daten von Erneuerbarer Energiequelle				
	Ölmenge	2 x 3.38 L				Einsatzgrenze	MIN [°C]	-10 (7)	
Maximaler Hochdruck - Kältemittel [bar]		50				Wärmequelle	MAX [°C]	30	
	PED Klasse	2				genauer siehe Betriebsgrenzendiagramm			
EVI - Dampfeinspritzung mit Economiser						Verdampfer	Anschlussdimension	VIC 2.1/2 "	
							Bauart	BPHE	
							Anzahl	1	
							Material	AISI 316	
						Maximaler Überdruck - Kältemittel [bar]			29
						Wärmeträger			Ethylenglykol
						Soleanteil [%]			29
						Gefrierschutz bis [°C]			-15
Daten von Elektroanschluss						Maximaler Überdruck - Ethylenglykol [bar]			6
Einspeisung [#~ V/Hz]			3~ 400/50			Volumenstrom - Ethylenglykol [m3/h]			7.37 ~ 14.75
Strom	Nominal [A]	43.28				Interne Druckdifferenz - Ethylenglykol [kPa]			20
	Maximal [A]	66.00				Temperaturdifferenz - Ethylenglykol			4 K
	Start [A]	58.42							
Sanftanlasser			-						
Hauptsicherung			C80						
Steuerungssystem									
Hauptregler	SIEMENS	RVS 61							
Erweiterungsmo dul	AVS75.3xx	AVS75.3xx	AVS75.372						
Bus Clip-In			Modbus OCI353						
Online-Verbindung	Web server OZW672		ToSyMo						
EEV Regelung			SEC61						
*** mit Zubehör									

ARB-WAMAK TBW 85 EVI

ErP (EU) No 811/2013: Technische Parameter für Wärmepumpen-Raumheizgeräte

Modell	TBW 85 EVI
Luft-Wasser-Wärmepumpe	nein
Sole/Wasser-Wärmepumpe	ja
Wasser/Wasser-Wärmepumpe	nein
Niedertemperatur-Wärmepumpe	nein
Ausgestattet mit einer Zusatzheizung	nein
Wärmepumpen-Kombi-Heizgerät	nein
Temperaturanwendung	niedrig (35°C - 30°C)
Klimaverhältnisse	durchschnittlich

Angabe	Symbol	Wert	Ein.	Angabe	Symbol	Wert	Ein.
Nennwärmeleistung bei Tdesignh	Prated	83.4	kW	Jahreszeitbedingte Raumheizungs-Energieeffizienz	ηs	200.9	%
Ausgewiesene Heizleistung für Teillast bei einer Innentemperatur von 20 °C und einer Außentemperatur von Tj				Deklarierte Leistungszahl oder Primärenergiekennzahl für Teillast bei einer Innentemperatur von 20 °C und einer Außentemperatur von Tj			
Tj = -7 °C	Pdh	83.4	kW	Tj = -7 °C	COPd	4.56	-
Tj = +2 °C	Pdh	83.3	kW	Tj = +2 °C	COPd	4.9	-
Tj = +7 °C	Pdh	41.6	kW	Tj = +7 °C	COPd	5.3	-
Tj = +12 °C	Pdh	41.6	kW	Tj = +12 °C	COPd	5.6	-
Tj = bivalente Temperatur	Pdh	83.4	kW	Tj = bivalente Temperatur	COPd	4.5	-
Tj = Betriebsgrenztemperatur	Pdh	---	kW	Tj = Betriebsgrenztemperatur	COPd	---	-
Bivalente Temperatur	Tbiv	-10	°C	Tj = Betriebsgrenztemperatur	TOL	---	°C
Stromverbrauch in anderen Modi als dem aktiven Modus				Betriebsgrenztemperatur des Heizwassers			
Aus-Zustand	Poff	0.010	kW	Zusatzheizung			
Thermostat-Aus-Modus	Pto	0.010	kW	Nennwärmeleistung	Psup	16.1	kW
Standby-Betrieb	Psb	0.010	kW	Art der Energiezufuhr			
Betriebsart Kurbelwannenheizung	Pck	0.000	kW	elektrisch			
Sonstige Angaben				Für Luft/Wasser-Wärmepumpen: - --- m3/h			
Leistungsregelung				Nennluftvolumenstrom, Außenbereich			
Schalleistungspegel				Für Wasser- oder Sole/Wasser-Wärmepumpen: Nenndurchfluss der Sole oder des Wassers, Wärmetauscher im Freien			
in Innenräumen	Lwa	65	dB	- 7.37 ~ 14.75 m3/h			
im Freien	Lwa	---	dB				
Jährlicher Energieverbrauch	QHE	172304.4	kWh				

Angaben zum Kontakt: ARB-Haustechnik GmbH, Thunstrasse 162 Postfach 33, 3074, Muri bei Bern, Switzerland, info@arb-ht.ch

ARB-WAMAK TBW 85 EVI

ErP (EU) No 811/2013: Technische Parameter für Wärmepumpen-Raumheizgeräte

Modell	TBW 85 EVI
Luft-Wasser-Wärmepumpe	nein
Sole/Wasser-Wärmepumpe	ja
Wasser/Wasser-Wärmepumpe	nein
Niedertemperatur-Wärmepumpe	nein
Ausgestattet mit einer Zusatzheizung	nein
Wärmepumpen-Kombi-Heizgerät	nein
Temperaturanwendung	mittel (55°C - 47°C)
Klimaverhältnisse	durchschnittlich

Angabe	Symbol	Wert	Ein.	Angabe	Symbol	Wert	Ein.
Nennwärmeleistung bei Tdesignh	Prated	85.0	kW	Jahreszeitbedingte Raumheizungs-Energieeffizienz	η_s	161.1	%
Ausgewiesene Heizleistung für Teillast bei einer Innentemperatur von 20 °C und einer Außentemperatur von Tj				Deklarierte Leistungszahl oder Primärenergiekennzahl für Teillast bei einer Innentemperatur von 20 °C und einer Außentemperatur von Tj			
Tj = -7 °C	Pdh	85.4	kW	Tj = -7 °C	COPd	3.30	-
Tj = +2 °C	Pdh	85.6	kW	Tj = +2 °C	COPd	4.2	-
Tj = +7 °C	Pdh	42.2	kW	Tj = +7 °C	COPd	4.6	-
Tj = +12 °C	Pdh	42.2	kW	Tj = +12 °C	COPd	5.0	-
Tj = bivalente Temperatur	Pdh	85.0	kW	Tj = bivalente Temperatur	COPd	2.9	-
Tj = Betriebsgrenztemperatur	Pdh	---	kW	Tj = Betriebsgrenztemperatur	COPd	---	-
Bivalente Temperatur	Tbiv	-10	°C	Tj = Betriebsgrenztemperatur	TOL	---	°C
Stromverbrauch in anderen Modi als dem aktiven Modus				Betriebsgrenztemperatur des Heizwassers			
Aus-Zustand	Poff	0.010	kW	Zusatzheizung			
Thermostat-Aus-Modus	Pto	0.010	kW	Nennwärmeleistung	Psup	16.1	kW
Standby-Betrieb	Psb	0.010	kW	Art der Energiezufuhr			
Betriebsart Kurbelwannenheizung	Pck	0.000	kW	elektrisch			
Sonstige Angaben				Für Luft/Wasser-Wärmepumpen: Nennluftvolumenstrom, Außenbereich			
Leistungsregelung		mehrstufig		Für Wasser- oder Sole/Wasser-Wärmepumpen: Nenndurchfluss der Sole oder des Wassers, Wärmetauscher im Freien			
Schalleistungspegel							
in Innenräumen	Lwa	65	dB				
im Freien	Lwa	---	dB				
Jährlicher Energieverbrauch	QHE	175610.0	kWh				

Angaben zum Kontakt: ARB-Haustechnik GmbH, Thunstrasse 162 Postfach 33, 3074, Muri bei Bern, Switzerland, info@arb-ht.ch



ENERG Y IJA
енергия - ενεργεια IE IA



WAMAK

TBW 85 EVI

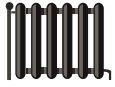

55 °C

35 °C

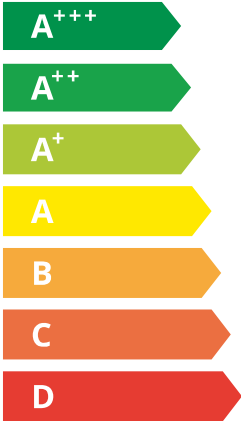

A+++

A+++



65 dB



--- dB

■ 90
■ 85
■ 84
kW

■ 86
■ 84
■ 80
kW



2019

811/2013

TBW 85 EVI

ErP Data

	55 °C	35 °C
Energy class	A+++	A+++
η [%]	161.1	200.9
P_{rated} [kW]	85	84
Q_{HE} [kWh/y]	175610	172305
SCOP [-]	4.03	5.02
$T_{bivalent}$ [°C]	-10	-10

CONTROLLER



+ QAA55/75
- QAA55/75

class VII
class III

3.5% ↓
1.5% ↓

Heizleistung Daten

Version: v2024.004-BW-WW

Quelle - Sole [0°C] / Niedrigtemp. [35°C]

ZHI40K1P-TFD_R410A_2_BWW

Betriebsbedingungen	Qh	P	COP
1 B0 / W30-35	83.4	18.7	4.46
2 B0 / W30-35 (MIN)	41.7	9.2	4.53
A B0 / Wxx-34	83.4	18.3	4.56
B B0 / Wxx-30	83.3	16.9	4.94
C B0 / Wxx-27	41.6	7.8	5.32
D B0 / Wxx-24	41.6	7.4	5.64
E B0 / Wxx-35	83.4	18.7	4.46
F B0 / Wxx-35	83.4	18.7	4.46

SCOP DATA EN 14825:2018	
Quelle - Sole [0°C] / Niedrigtemp. [35°C]	
SCOPon	5.03
SCOPnet	5.03
SCOP	5.02
η [%]	200.87
Label	A+++
Qh [kWh]	172304
Pdesignh [kW]	83.4
Tbivalent [°C]	-10

Quelle - Sole [0°C] / Mitteltemp.. [55°C]

Betriebsbedingungen	Qh	P	COP
1 B0 / W47-55	85.0	29.5	2.88
2 B0 / W47-55 (MIN)	42.5	14.4	2.92
A B0 / Wxx-52	85.4	26.8	3.30
B B0 / Wxx-42	85.6	20.8	4.16
C B0 / Wxx-36	42.2	9.1	4.63
D B0 / Wxx-30	42.2	8.3	5.07
E B0 / Wxx-55	85.0	29.5	2.88
F B0 / Wxx-54	85.5	27.4	3.12

SCOP DATA EN 14825:2018	
Quelle - Sole [0°C] / Mitteltemp.. [55°C]	
SCOPon	4.03
SCOPnet	4.03
SCOP	4.03
η [%]	161.09
Label	A+++
Qh [kWh]	175610
Pdesignh [kW]	85.0
Tbivalent [°C]	-10

Quelle - Wasser [10°C] / Niedrigtemp. [35°C]

Betriebsbedingungen	Qh	P	COP
1 W10 / W30-35	106.5	18.9	5.65
2 W10 / W30-35 (MIN)	53.3	9.3	5.73
A W10 / Wxx-34	106.6	18.5	5.77
B W10 / Wxx-30	106.8	17.0	6.27
C W10 / Wxx-27	53.5	7.9	6.76
D W10 / Wxx-24	53.5	7.4	7.18
E W10 / Wxx-35	106.5	18.9	5.65
F W10 / Wxx-35	106.5	18.9	5.65

SCOP DATA EN 14825:2018	
Quelle - Wasser [10°C] / Niedrigtemp. [35°C]	
SCOPon	6.38
SCOPnet	6.38
SCOP	6.38
η [%]	255.04
Label	A+++
Qh [kWh]	220029
Pdesignh [kW]	106.5
Tbivalent [°C]	-10.00

Quelle - Wasser [10°C] / Mitteltemp. [55°C]

Betriebsbedingungen		Qh	P	COP
1	W10 / W47-55	106.6	29.8	3.58
2	W10 / W47-55 (MIN)	53.3	14.7	3.63
A	W10 / Wxx-52	107.5	27.0	3.98
B	W10 / Wxx-42	107.6	21.0	5.12
C	W10 / Wxx-36	53.9	9.2	5.85
D	W10 / Wxx-30	54.0	8.4	6.43
E	W10 / Wxx-55	106.6	29.8	3.58
F	W10 / Wxx-55	106.6	29.8	3.58

SCOP DATA EN 14825:2018	
Quelle - Wasser [10°C] / Mitteltemp. [55°C]	
SCOPon	4.96
SCOPnet	4.96
SCOP	4.95
η [%]	198.16
Label	A+++
Qh [kWh]	220236
Pdesignh [kW]	106.6
Tbivalent [°C]	-10.00

Niedrigtemperatur Kühlung W 12 / 7°C

Betriebsbedingungen		Qc	P	EER
A	W30-35 / W12-7	64.9	19.9	3.26
B	W26-xx / W12-7	66.3	18.3	3.62
C	W22-xx / W12-7	67.6	16.9	4.01
D	W18-xx / W12-7	68.2	16.2	4.21

SEER DATA EN 14825:2018 [W 12 / 7°C]	
SEERon	3.89
SEER	3.89
Qc [kWh]	37740
η [%]	155.45

Flächenkühlung W 23 / 18°C

Betriebsbedingungen		Qc	P	EER
A	W50-xx / W23-18	76.9	31.8	2.42
B	W40-xx / W23-18	82.7	24.9	3.32
C	W30-35 / W23-18	87.6	19.9	4.40
D	W26-xx / W23-18	89.3	18.3	4.88

SEER DATA EN 14825:2018 [W 23 / 18°C]	
SEERon	5.23
SEER	5.23
Qc [kWh]	37740
η [%]	209.16

Leistungslinien - Heizen

- Qh-nom-35 - - - Qh-min-35 - - - - Qh-max-65 — Qh-nom-45 — Qh-nom-55
- Qh-nom-65

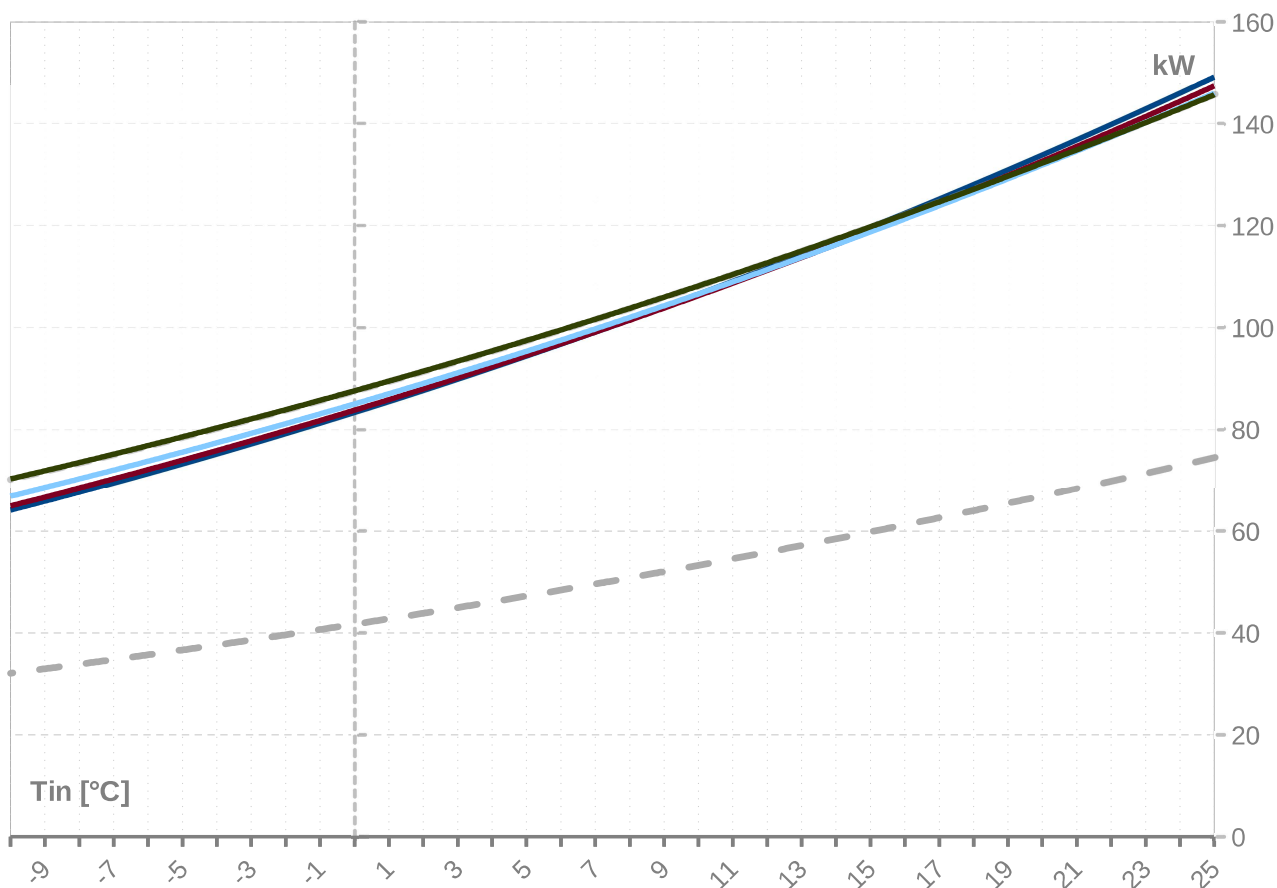

Leistungslinien - Kühlen

- Qc-nom-12-7 — Qc-nom-23-18

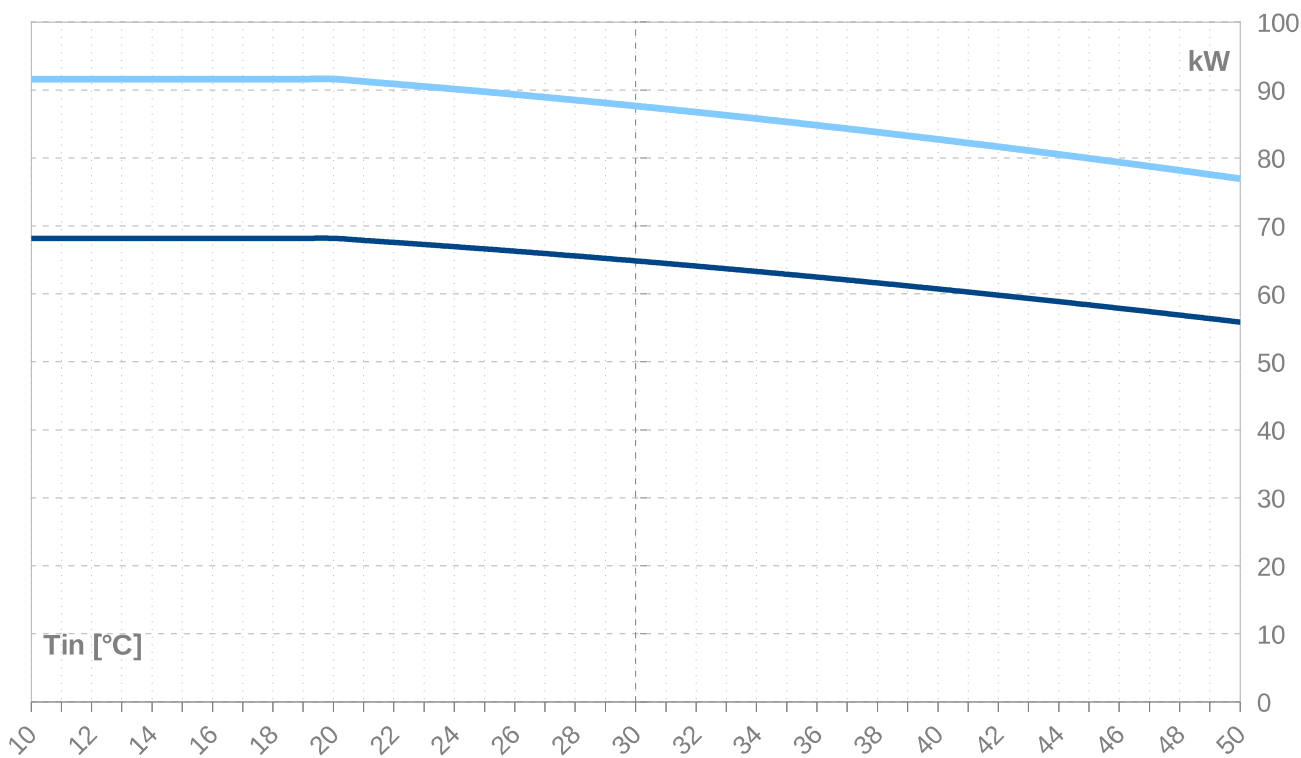

Tws -VL		35										
	[°C]	Qh nom	Qh min	Qh max	Pin nom	Pin min	Pin max	COP nom	Qc nom	Qc min	Qc max	I nom
Twq -RL	[°C]	[kW]	[kW]	[kW]	[kW]	[kW]	[kW]	kw / kw	[kW]	[kW]	[kW]	[A]
25	149.2	74.6	149.2	19.2	9.5	19.2	7.78	131.3	65.6	131.3	43.2	
24	146.0	73.0	146.0	19.2	9.4	19.2	7.62	128.1	64.1	128.1	43.2	
23	142.9	71.5	142.9	19.1	9.4	19.1	7.47	125.0	62.5	125.0	43.2	
22	139.8	69.9	139.8	19.1	9.4	19.1	7.32	122.0	61.0	122.0	43.2	
21	136.8	68.4	136.8	19.1	9.4	19.1	7.17	119.0	59.5	119.0	43.3	
20	133.9	66.9	133.9	19.1	9.4	19.1	7.02	116.1	58.0	116.1	43.3	
19	130.9	65.5	130.9	19.0	9.4	19.0	6.87	113.1	56.6	113.1	43.3	
18	128.1	64.0	128.1	19.0	9.4	19.0	6.73	110.3	55.1	110.3	43.3	
17	125.2	62.6	125.2	19.0	9.4	19.0	6.59	107.5	53.7	107.5	43.4	
16	122.4	61.2	122.4	19.0	9.4	19.0	6.45	104.7	52.3	104.7	43.4	
15	119.7	59.8	119.7	19.0	9.4	19.0	6.31	102.0	51.0	102.0	43.4	
14	117.0	58.5	117.0	18.9	9.3	18.9	6.17	99.3	49.6	99.3	43.4	
13	114.3	57.1	114.3	18.9	9.3	18.9	6.04	96.6	48.3	96.6	43.5	
12	111.7	55.8	111.7	18.9	9.3	18.9	5.91	94.0	47.0	94.0	43.5	
11	109.1	54.5	109.1	18.9	9.3	18.9	5.78	91.5	45.7	91.5	43.5	
10	106.5	53.3	106.5	18.9	9.3	18.9	5.65	88.9	44.5	88.9	43.5	
9	104.1	52.0	104.1	18.8	9.3	18.8	5.52	86.5	43.2	86.5	43.5	
8	101.6	50.8	101.6	18.8	9.3	18.8	5.40	84.0	42.0	84.0	43.5	
7	99.2	49.6	99.2	18.8	9.3	18.8	5.27	81.6	40.8	81.6	43.5	
6	96.8	48.4	96.8	18.8	9.3	18.8	5.15	79.3	39.6	79.3	43.6	
5	94.5	47.2	94.5	18.8	9.3	18.8	5.03	76.9	38.5	76.9	43.6	
4	92.2	46.1	92.2	18.8	9.2	18.8	4.92	74.7	37.3	74.7	43.6	
3	89.9	45.0	89.9	18.7	9.2	18.7	4.80	72.4	36.2	72.4	43.6	
2	87.7	43.9	87.7	18.7	9.2	18.7	4.69	70.2	35.1	70.2	43.6	
1	85.5	42.8	85.5	18.7	9.2	18.7	4.57	68.1	34.0	68.1	43.6	
0	83.4	41.7	83.4	18.7	9.2	18.7	4.46	65.9	33.0	65.9	43.6	
-1	81.3	40.6	81.3	18.7	9.2	18.7	4.35	63.9	31.9	63.9	43.6	
-2	79.2	39.6	79.2	18.7	9.2	18.7	4.25	61.8	30.9	61.8	43.6	
-3	77.2	38.6	77.2	18.6	9.2	18.6	4.14	59.8	29.9	59.8	43.6	
-4	75.2	37.6	75.2	18.6	9.2	18.6	4.04	57.8	28.9	57.8	43.6	
-5	73.3	36.6	73.3	18.6	9.2	18.6	3.94	55.9	28.0	55.9	43.6	
-6	71.4	35.7	71.4	18.6	9.2	18.6	3.84	54.0	27.0	54.0	43.6	
-7	69.5	34.8	69.5	18.6	9.2	18.6	3.74	52.2	26.1	52.2	43.6	
-8	67.7	33.8	67.7	18.6	9.2	18.6	3.65	50.3	25.2	50.3	43.6	
-9	65.9	32.9	65.9	18.6	9.2	18.6	3.55	48.6	24.3	48.6	43.5	
-10	64.1	32.1	64.1	18.5	9.1	18.5	3.46	46.8	23.4	46.8	43.5	
-11	62.4	31.2	62.4	18.5	9.1	18.5	3.37	45.1	22.6	45.1	43.5	
-12	60.7	30.4	60.7	18.5	9.1	18.5	3.28	43.4	21.7	43.4	43.5	
-13	59.1	29.5	59.1	18.5	9.1	18.5	3.19	41.8	20.9	41.8	43.4	
-14	57.5	28.7	57.5	18.5	9.1	18.5	3.10	40.2	20.1	40.2	43.4	
-15	55.9	27.9	55.9	18.5	9.1	18.5	3.02	38.6	19.3	38.6	43.4	

-- Achtung: Betriebsgrenzen beachten - nicht in Tabelle festgehalten

ZHI40K1P-TFD_R410A_2_BWW

Tws -VL		45										
	[°C]	Qh nom	Qh min	Qh max	Pin nom	Pin min	Pin max	COP nom	Qc nom	Qc min	Qc max	I nom
Twq -RL	[°C]	[kW]	[kW]	[kW]	[kW]	[kW]	[kW]	kW / kW	[kW]	[kW]	[kW]	[A]
25	147.5	73.7	147.5	23.6	11.6	23.6	6.25	125.4	62.7	125.4	48.0	
24	144.4	72.2	144.4	23.6	11.6	23.6	6.12	122.4	61.2	122.4	48.0	
23	141.4	70.7	141.4	23.6	11.6	23.6	6.00	119.4	59.7	119.4	47.9	
22	138.5	69.2	138.5	23.5	11.6	23.5	5.89	116.5	58.2	116.5	47.9	
21	135.5	67.8	135.5	23.5	11.6	23.5	5.77	113.6	56.8	113.6	47.9	
20	132.7	66.3	132.7	23.5	11.6	23.5	5.65	110.8	55.4	110.8	47.8	
19	129.8	64.9	129.8	23.4	11.6	23.4	5.54	108.0	54.0	108.0	47.8	
18	127.1	63.5	127.1	23.4	11.5	23.4	5.43	105.2	52.6	105.2	47.8	
17	124.3	62.2	124.3	23.4	11.5	23.4	5.32	102.5	51.2	102.5	47.8	
16	121.6	60.8	121.6	23.4	11.5	23.4	5.21	99.8	49.9	99.8	47.7	
15	118.9	59.5	118.9	23.3	11.5	23.3	5.10	97.2	48.6	97.2	47.7	
14	116.3	58.2	116.3	23.3	11.5	23.3	4.99	94.6	47.3	94.6	47.7	
13	113.7	56.9	113.7	23.3	11.5	23.3	4.89	92.0	46.0	92.0	47.7	
12	111.2	55.6	111.2	23.3	11.5	23.3	4.78	89.5	44.7	89.5	47.6	
11	108.7	54.3	108.7	23.2	11.5	23.2	4.68	87.0	43.5	87.0	47.6	
10	106.2	53.1	106.2	23.2	11.4	23.2	4.58	84.6	42.3	84.6	47.6	
9	103.8	51.9	103.8	23.2	11.4	23.2	4.48	82.2	41.1	82.2	47.6	
8	101.4	50.7	101.4	23.2	11.4	23.2	4.38	79.8	39.9	79.8	47.5	
7	99.1	49.5	99.1	23.1	11.4	23.1	4.28	77.5	38.7	77.5	47.5	
6	96.8	48.4	96.8	23.1	11.4	23.1	4.19	75.2	37.6	75.2	47.5	
5	94.5	47.3	94.5	23.1	11.4	23.1	4.09	72.9	36.5	72.9	47.4	
4	92.3	46.1	92.3	23.1	11.4	23.1	4.00	70.7	35.4	70.7	47.4	
3	90.1	45.0	90.1	23.1	11.4	23.1	3.91	68.6	34.3	68.6	47.4	
2	87.9	44.0	87.9	23.0	11.4	23.0	3.82	66.4	33.2	66.4	47.4	
1	85.8	42.9	85.8	23.0	11.3	23.0	3.73	64.3	32.2	64.3	47.3	
0	83.7	41.9	83.7	23.0	11.3	23.0	3.64	62.3	31.1	62.3	47.3	
-1	81.7	40.8	81.7	23.0	11.3	23.0	3.56	60.2	30.1	60.2	47.3	
-2	79.7	39.8	79.7	23.0	11.3	23.0	3.47	58.3	29.1	58.3	47.2	
-3	77.7	38.9	77.7	22.9	11.3	22.9	3.39	56.3	28.2	56.3	47.2	
-4	75.8	37.9	75.8	22.9	11.3	22.9	3.31	54.4	27.2	54.4	47.2	
-5	73.9	36.9	73.9	22.9	11.3	22.9	3.23	52.5	26.3	52.5	47.1	
-6	72.0	36.0	72.0	22.9	11.3	22.9	3.15	50.7	25.3	50.7	47.1	
-7	70.2	35.1	70.2	22.9	11.3	22.9	3.07	48.8	24.4	48.8	47.1	
-8	68.4	34.2	68.4	22.9	11.3	22.9	2.99	47.1	23.5	47.1	47.0	
-9	66.7	33.3	66.7	22.9	11.3	22.9	2.92	45.3	22.7	45.3	47.0	
-10	65.0	32.5	65.0	22.9	11.3	22.9	2.84	43.6	21.8	43.6	46.9	
-11	63.3	31.6	63.3	22.8	11.3	22.8	2.77	41.9	21.0	41.9	46.9	
-12	61.6	30.8	61.6	22.8	11.3	22.8	2.70	40.3	20.1	40.3	46.9	
-13	60.0	30.0	60.0	22.8	11.3	22.8	2.63	38.7	19.3	38.7	46.8	
-14	58.4	29.2	58.4	22.8	11.3	22.8	2.56	37.1	18.6	37.1	46.8	
-15	56.9	28.4	56.9	22.8	11.3	22.8	2.49	35.6	17.8	35.6	46.7	

-- Achtung: Betriebsgrenzen beachten - nicht in Tabelle festgehalten

Tws -VL		55										
	[°C]	Qh nom	Qh min	Qh max	Pin nom	Pin min	Pin max	COP nom	Qc nom	Qc min	Qc max	I nom
Twq -RL	[°C]	[kW]	[kW]	[kW]	[kW]	[kW]	[kW]	kw / kw	[kW]	[kW]	[kW]	[A]
25		146.0	73.0	146.0	30.3	14.9	30.3	4.83	117.8	58.9	117.8	54.9
24		143.1	71.6	143.1	30.2	14.9	30.2	4.74	114.9	57.5	114.9	54.8
23		140.3	70.1	140.3	30.2	14.9	30.2	4.65	112.1	56.0	112.1	54.8
22		137.4	68.7	137.4	30.2	14.9	30.2	4.56	109.3	54.6	109.3	54.7
21		134.6	67.3	134.6	30.1	14.9	30.1	4.47	106.5	53.3	106.5	54.7
20		131.9	65.9	131.9	30.1	14.8	30.1	4.38	103.8	51.9	103.8	54.6
19		129.2	64.6	129.2	30.0	14.8	30.0	4.30	101.1	50.6	101.1	54.6
18		126.5	63.3	126.5	30.0	14.8	30.0	4.22	98.5	49.2	98.5	54.5
17		123.9	61.9	123.9	30.0	14.8	30.0	4.13	95.9	47.9	95.9	54.5
16		121.3	60.7	121.3	29.9	14.8	29.9	4.05	93.3	46.7	93.3	54.4
15		118.8	59.4	118.8	29.9	14.8	29.9	3.97	90.8	45.4	90.8	54.4
14		116.2	58.1	116.2	29.9	14.7	29.9	3.89	88.3	44.2	88.3	54.3
13		113.8	56.9	113.8	29.9	14.7	29.9	3.81	85.9	42.9	85.9	54.3
12		111.3	55.7	111.3	29.8	14.7	29.8	3.73	83.5	41.7	83.5	54.2
11		108.9	54.5	108.9	29.8	14.7	29.8	3.66	81.1	40.6	81.1	54.2
10		106.6	53.3	106.6	29.8	14.7	29.8	3.58	78.8	39.4	78.8	54.2
9		104.2	52.1	104.2	29.7	14.7	29.7	3.51	76.5	38.2	76.5	54.1
8		102.0	51.0	102.0	29.7	14.7	29.7	3.43	74.2	37.1	74.2	54.1
7		99.7	49.9	99.7	29.7	14.6	29.7	3.36	72.0	36.0	72.0	54.0
6		97.5	48.7	97.5	29.7	14.6	29.7	3.29	69.8	34.9	69.8	54.0
5		95.3	47.7	95.3	29.6	14.6	29.6	3.22	67.6	33.8	67.6	54.0
4		93.2	46.6	93.2	29.6	14.6	29.6	3.15	65.5	32.8	65.5	53.9
3		91.1	45.5	91.1	29.6	14.6	29.6	3.08	63.4	31.7	63.4	53.9
2		89.0	44.5	89.0	29.6	14.6	29.6	3.01	61.4	30.7	61.4	53.9
1		87.0	43.5	87.0	29.5	14.6	29.5	2.94	59.4	29.7	59.4	53.8
0		85.0	42.5	85.0	29.5	14.6	29.5	2.88	57.4	28.7	57.4	53.8
-1		83.0	41.5	83.0	29.5	14.6	29.5	2.81	55.4	27.7	55.4	53.8
-2		81.1	40.5	81.1	29.5	14.5	29.5	2.75	53.5	26.8	53.5	53.7
-3		79.2	39.6	79.2	29.5	14.5	29.5	2.69	51.7	25.8	51.7	53.7
-4		77.3	38.7	77.3	29.5	14.5	29.5	2.62	49.8	24.9	49.8	53.7
-5		75.5	37.7	75.5	29.4	14.5	29.4	2.56	48.0	24.0	48.0	53.6
-6		73.7	36.8	73.7	29.4	14.5	29.4	2.50	46.2	23.1	46.2	53.6
-7		71.9	36.0	71.9	29.4	14.5	29.4	2.45	44.5	22.2	44.5	53.6
-8		70.2	35.1	70.2	29.4	14.5	29.4	2.39	42.7	21.4	42.7	53.6
-9		68.5	34.3	68.5	29.4	14.5	29.4	2.33	41.1	20.5	41.1	53.5
-10		66.9	33.4	66.9	29.4	14.5	29.4	2.27	39.4	19.7	39.4	53.5
-11		65.2	32.6	65.2	29.4	14.5	29.4	2.22	37.8	18.9	37.8	53.5
-12		63.6	31.8	63.6	29.4	14.5	29.4	2.17	36.2	18.1	36.2	53.4
-13		62.1	31.0	62.1	29.4	14.5	29.4	2.11	34.6	17.3	34.6	53.4
-14		60.5	30.3	60.5	29.4	14.5	29.4	2.06	33.1	16.5	33.1	53.4
-15		59.0	29.5	59.0	29.4	14.5	29.4	2.01	31.6	15.8	31.6	53.3

-- Achtung: Betriebsgrenzen beachten - nicht in Tabelle festgehalten

Tws -VL	65 (T-max)										
	[°C]	Qh nom	Qh min	Qh max	Pin nom	Pin min	Pin max	COP nom	Qc nom	Qc min	Qc max
[°C]	[kW]	[kW]	[kW]	[kW]	[kW]	[kW]	kW / kW	[kW]	[kW]	[kW]	[A]
25	145.7	72.9	145.7	38.8	19.2	38.8	3.75	109.4	54.7	109.4	65.7
24	143.0	71.5	143.0	38.8	19.1	38.8	3.68	106.7	53.4	106.7	65.7
23	140.2	70.1	140.2	38.8	19.1	38.8	3.62	104.0	52.0	104.0	65.6
22	137.5	68.8	137.5	38.7	19.1	38.7	3.55	101.4	50.7	101.4	65.6
21	134.9	67.4	134.9	38.7	19.1	38.7	3.49	98.8	49.4	98.8	65.5
20	132.3	66.1	132.3	38.6	19.1	38.6	3.42	96.2	48.1	96.2	65.5
19	129.7	64.8	129.7	38.6	19.0	38.6	3.36	93.6	46.8	93.6	65.4
18	127.1	63.6	127.1	38.6	19.0	38.6	3.30	91.1	45.6	91.1	65.4
17	124.6	62.3	124.6	38.5	19.0	38.5	3.24	88.7	44.3	88.7	65.4
16	122.2	61.1	122.2	38.5	19.0	38.5	3.17	86.2	43.1	86.2	65.3
15	119.7	59.9	119.7	38.4	19.0	38.4	3.11	83.8	41.9	83.8	65.3
14	117.4	58.7	117.4	38.4	18.9	38.4	3.06	81.5	40.7	81.5	65.3
13	115.0	57.5	115.0	38.4	18.9	38.4	3.00	79.2	39.6	79.2	65.2
12	112.7	56.3	112.7	38.3	18.9	38.3	2.94	76.9	38.4	76.9	65.2
11	110.4	55.2	110.4	38.3	18.9	38.3	2.88	74.6	37.3	74.6	65.2
10	108.1	54.1	108.1	38.3	18.9	38.3	2.83	72.4	36.2	72.4	65.2
9	105.9	53.0	105.9	38.3	18.9	38.3	2.77	70.2	35.1	70.2	65.1
8	103.8	51.9	103.8	38.2	18.9	38.2	2.71	68.1	34.0	68.1	65.1
7	101.6	50.8	101.6	38.2	18.8	38.2	2.66	65.9	33.0	65.9	65.1
6	99.5	49.7	99.5	38.2	18.8	38.2	2.61	63.9	31.9	63.9	65.1
5	97.4	48.7	97.4	38.1	18.8	38.1	2.55	61.8	30.9	61.8	65.1
4	95.4	47.7	95.4	38.1	18.8	38.1	2.50	59.8	29.9	59.8	65.1
3	93.4	46.7	93.4	38.1	18.8	38.1	2.45	57.8	28.9	57.8	65.1
2	91.4	45.7	91.4	38.1	18.8	38.1	2.40	55.8	27.9	55.8	65.1
1	89.5	44.7	89.5	38.0	18.8	38.0	2.35	53.9	27.0	53.9	65.1
0	87.5	43.8	87.5	38.0	18.8	38.0	2.30	52.0	26.0	52.0	65.1
-1	85.7	42.8	85.7	38.0	18.7	38.0	2.25	50.2	25.1	50.2	65.1
-2	83.8	41.9	83.8	38.0	18.7	38.0	2.21	48.3	24.2	48.3	65.1
-3	82.0	41.0	82.0	38.0	18.7	38.0	2.16	46.6	23.3	46.6	65.1
-4	80.2	40.1	80.2	38.0	18.7	38.0	2.11	44.8	22.4	44.8	65.1
-5	78.5	39.2	78.5	37.9	18.7	37.9	2.07	43.0	21.5	43.0	65.1
-6	76.8	38.4	76.8	37.9	18.7	37.9	2.02	41.3	20.7	41.3	65.1
-7	75.1	37.5	75.1	37.9	18.7	37.9	1.98	39.7	19.8	39.7	65.1
-8	73.4	36.7	73.4	37.9	18.7	37.9	1.94	38.0	19.0	38.0	65.1
-9	71.8	35.9	71.8	37.9	18.7	37.9	1.89	36.4	18.2	36.4	65.1
-10	70.2	35.1	70.2	37.9	18.7	37.9	1.85	34.8	17.4	34.8	65.1
-11	68.6	34.3	68.6	37.9	18.7	37.9	1.81	33.3	16.6	33.3	65.1
-12	67.1	33.6	67.1	37.9	18.7	37.9	1.77	31.7	15.9	31.7	65.1
-13	65.6	32.8	65.6	37.9	18.7	37.9	1.73	30.2	15.1	30.2	65.1
-14	64.1	32.1	64.1	37.9	18.7	37.9	1.69	28.7	14.4	28.7	65.2
-15	62.7	31.3	62.7	37.9	18.7	37.9	1.65	27.3	13.6	27.3	65.2

-- Achtung: Betriebsgrenzen beachten - nicht in Tabelle festgehalten

Tk -VL	W 12 / 7 °C										
[°C]	Qc nom [kW]	Qc min [kW]	Qc max [kW]	Pin nom [kW]	Pin min [kW]	Pin max [kW]	EER kW / kW	Qh nom [kW]	Qh min [kW]	Qh max [kW]	I nom [A]
40	60.7	30.4	60.7	24.9	12.3	24.9	2.44	84.0	42.0	84.0	49.0
39	61.2	30.6	61.2	24.4	12.0	24.4	2.51	83.9	42.0	83.9	48.5
38	61.6	30.8	61.6	23.8	11.7	23.8	2.59	83.8	41.9	83.8	48.0
37	62.1	31.0	62.1	23.3	11.5	23.3	2.67	83.8	41.9	83.8	47.5
36	62.5	31.2	62.5	22.7	11.2	22.7	2.75	83.7	41.9	83.7	47.1
35	62.9	31.4	62.9	22.2	11.0	22.2	2.83	83.7	41.8	83.7	46.6
34	63.3	31.7	63.3	21.7	10.7	21.7	2.91	83.6	41.8	83.6	46.2
33	63.7	31.9	63.7	21.3	10.5	21.3	3.00	83.6	41.8	83.6	45.8
32	64.1	32.0	64.1	20.8	10.3	20.8	3.08	83.5	41.8	83.5	45.4
31	64.5	32.2	64.5	20.3	10.0	20.3	3.17	83.5	41.7	83.5	45.1
30	64.9	32.4	64.9	19.9	9.8	19.9	3.26	83.5	41.7	83.5	44.7
29	65.2	32.6	65.2	19.5	9.6	19.5	3.35	83.4	41.7	83.4	44.3
28	65.6	32.8	65.6	19.1	9.4	19.1	3.44	83.4	41.7	83.4	44.0
27	65.9	33.0	65.9	18.7	9.2	18.7	3.53	83.4	41.7	83.4	43.6
26	66.3	33.1	66.3	18.3	9.0	18.3	3.62	83.4	41.7	83.4	43.2
25	66.6	33.3	66.6	17.9	8.8	17.9	3.72	83.4	41.7	83.4	42.9
24	66.9	33.5	66.9	17.6	8.7	17.6	3.81	83.3	41.7	83.3	42.5
23	67.3	33.6	67.3	17.2	8.5	17.2	3.91	83.3	41.7	83.3	42.1
22	67.6	33.8	67.6	16.9	8.3	16.9	4.01	83.3	41.7	83.3	41.7
21	67.9	33.9	67.9	16.5	8.2	16.5	4.11	83.3	41.7	83.3	41.3
20	68.2	34.1	68.2	16.2	8.0	16.2	4.21	83.3	41.7	83.3	40.8

Tc [°C]	W 23 / 18 °C										
[°C]	Qc nom [kW]	Qc min [kW]	Qc max [kW]	Pin nom [kW]	Pin min [kW]	Pin max [kW]	EER kW / kW	Qh nom [kW]	Qh min [kW]	Qh max [kW]	I nom [A]
40	82.7	41.4	82.7	24.9	12.3	24.9	3.32	106.2	53.1	106.9	49.4
39	83.3	41.6	83.3	24.4	12.0	24.4	3.42	106.2	53.1	106.8	48.8
38	83.8	41.9	83.8	23.8	11.7	23.8	3.52	106.2	53.1	106.7	48.3
37	84.3	42.2	84.3	23.3	11.5	23.3	3.62	106.2	53.1	106.6	47.8
36	84.8	42.4	84.8	22.7	11.2	22.7	3.73	106.2	53.1	106.5	47.3
35	85.3	42.7	85.3	22.2	11.0	22.2	3.84	106.3	53.1	106.4	46.9
34	85.8	42.9	85.8	21.7	10.7	21.7	3.95	106.3	53.1	106.4	46.4
33	86.3	43.1	86.3	21.3	10.5	21.3	4.06	106.3	53.2	106.3	46.0
32	86.7	43.4	86.7	20.8	10.3	20.8	4.17	106.3	53.2	106.3	45.6
31	87.2	43.6	87.2	20.3	10.0	20.3	4.29	106.4	53.2	106.3	45.2
30	87.6	43.8	87.6	19.9	9.8	19.9	4.40	106.4	53.2	106.2	44.7
29	88.1	44.0	88.1	19.5	9.6	19.5	4.52	106.5	53.2	106.2	44.3
28	88.5	44.3	88.5	19.1	9.4	19.1	4.64	106.5	53.3	106.2	43.9
27	88.9	44.5	88.9	18.7	9.2	18.7	4.76	106.5	53.3	106.2	43.5
26	89.3	44.7	89.3	18.3	9.0	18.3	4.88	106.6	53.3	106.2	43.1
25	89.7	44.9	89.7	17.9	8.8	17.9	5.01	106.6	53.3	106.3	42.7
24	90.1	45.1	90.1	17.6	8.7	17.6	5.13	106.7	53.3	106.3	42.2
23	90.5	45.3	90.5	17.2	8.5	17.2	5.26	106.7	53.4	106.3	41.8
22	90.9	45.4	90.9	16.9	8.3	16.9	5.39	106.8	53.4	106.3	41.3
21	91.2	45.6	91.2	16.5	8.2	16.5	5.52	106.8	53.4	106.4	40.8
20	91.6	45.8	91.6	16.2	8.0	16.2	5.65	106.9	53.4	106.4	40.3

-- Achtung: Betriebsgrenzen beachten - nicht in Tabelle festgehalten

LEGENDE:

T_{wq-RL} : Temperatur Wärmequelle - Eintritt [°C]

T_{ws-VL} : Temperatur Wärmesenke - Vorlauf [°C]

T_{k-VL} : Temperatur Kältesenke - Vorlauf [°C]

Q_h nom: Heizleistung nominal

Q_h min: Heizleistung minimal

Q_h max: Heizleistung maximal

P_{in} nom: Aufnahme bei nominaler Heizleistung

P_{in} min: Aufnahme bei minimaler Heizleistung

P_{in} max: Aufnahme bei maximaler Heizleistung

COP nom: Arbeitszahl bei nominaler Heizleistung

Q_c nom: Kälteleistung/Energieentnahme bei nominaler Heizleistung

Q_c min: Kälteleistung/Energieentnahme bei minimaler Heizleistung

Q_c max: Kälteleistung/Energieentnahme bei maximaler Heizleistung

I nom: Stromaufnahme bei nominaler Heizleistung

EER: Arbeitszahl bei nominaler Kälteleistung

Betriebsgrenzen

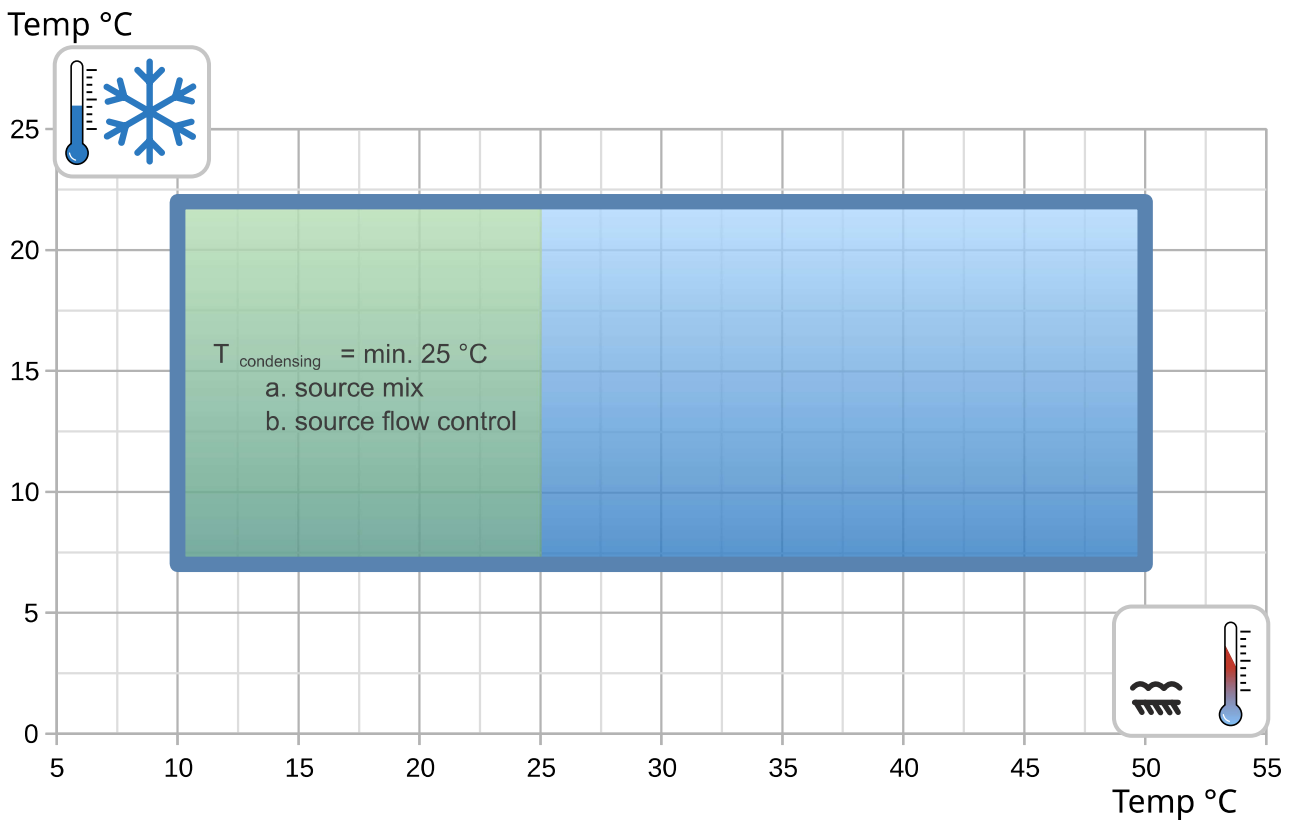
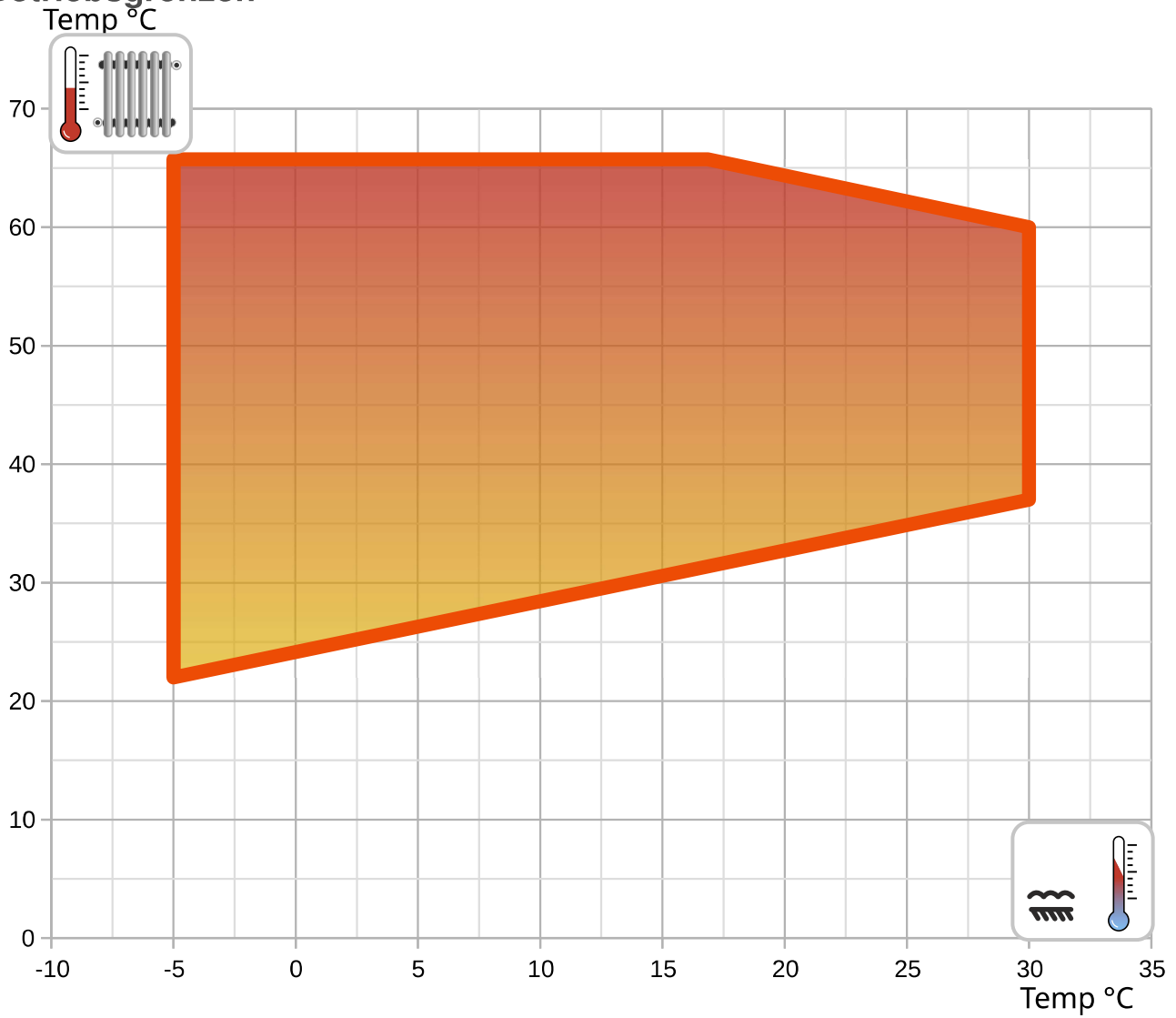

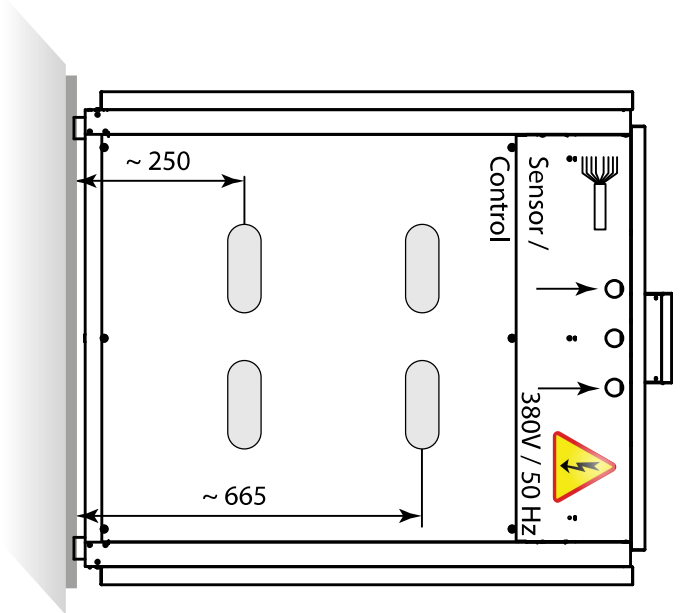
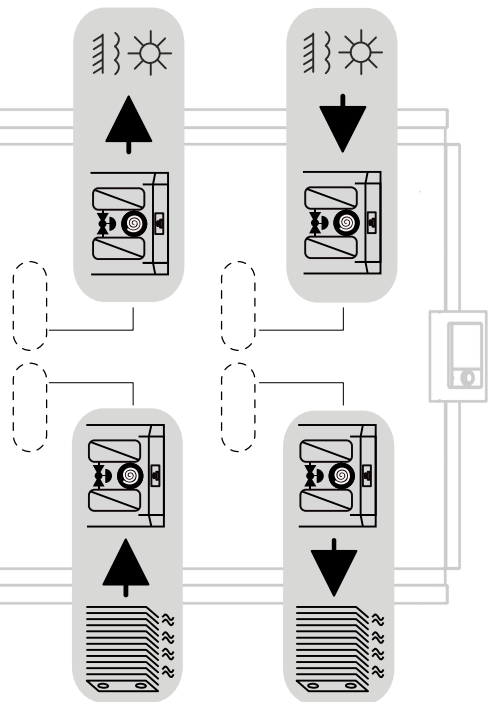
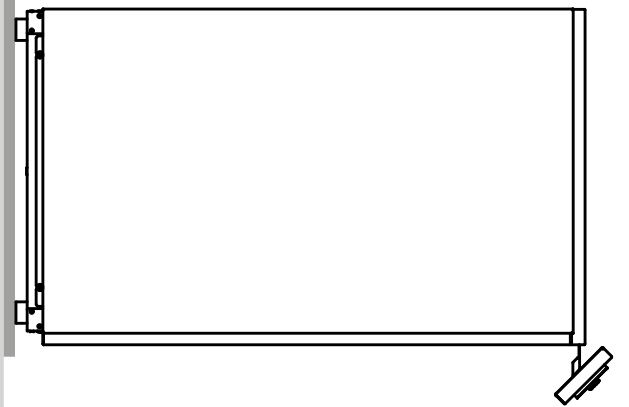
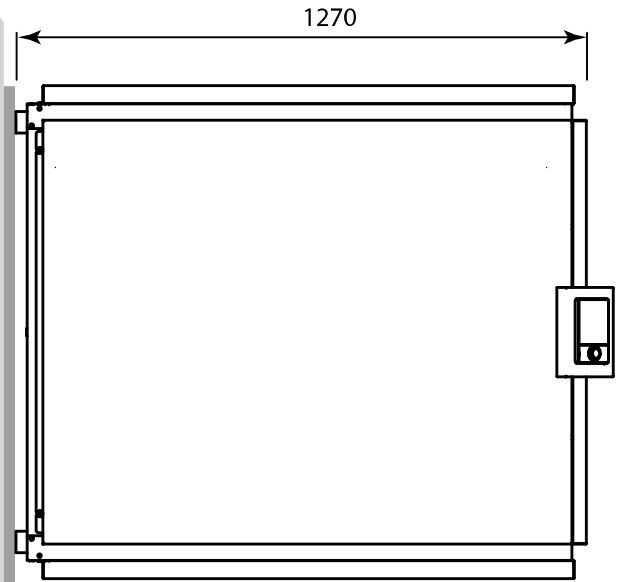
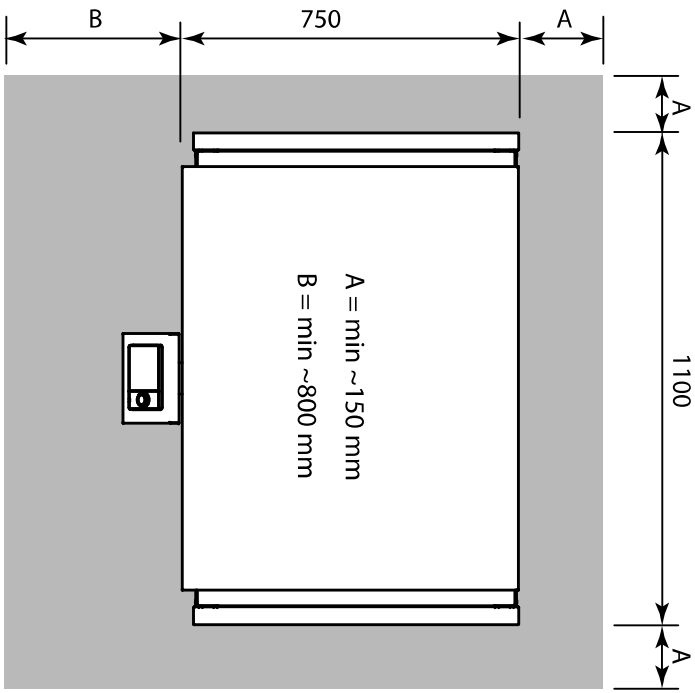

int. code: VN1100

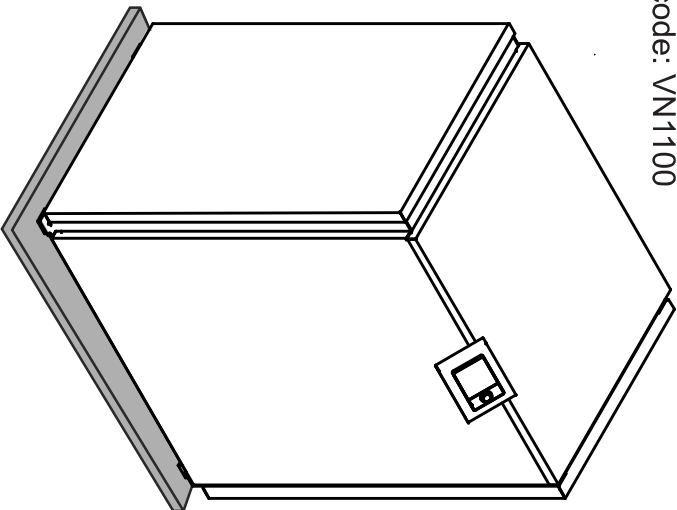

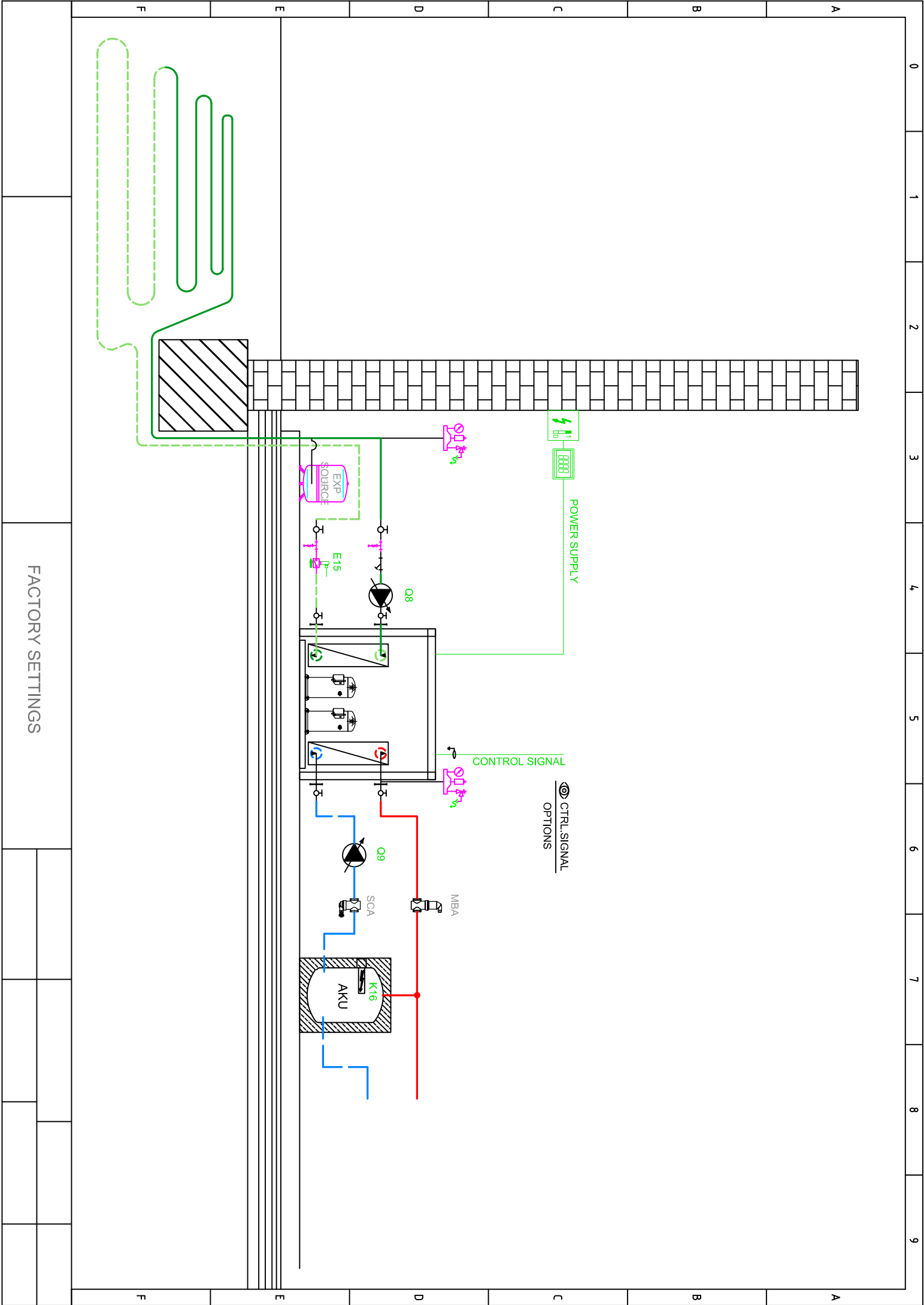

FACTORY SETTINGS

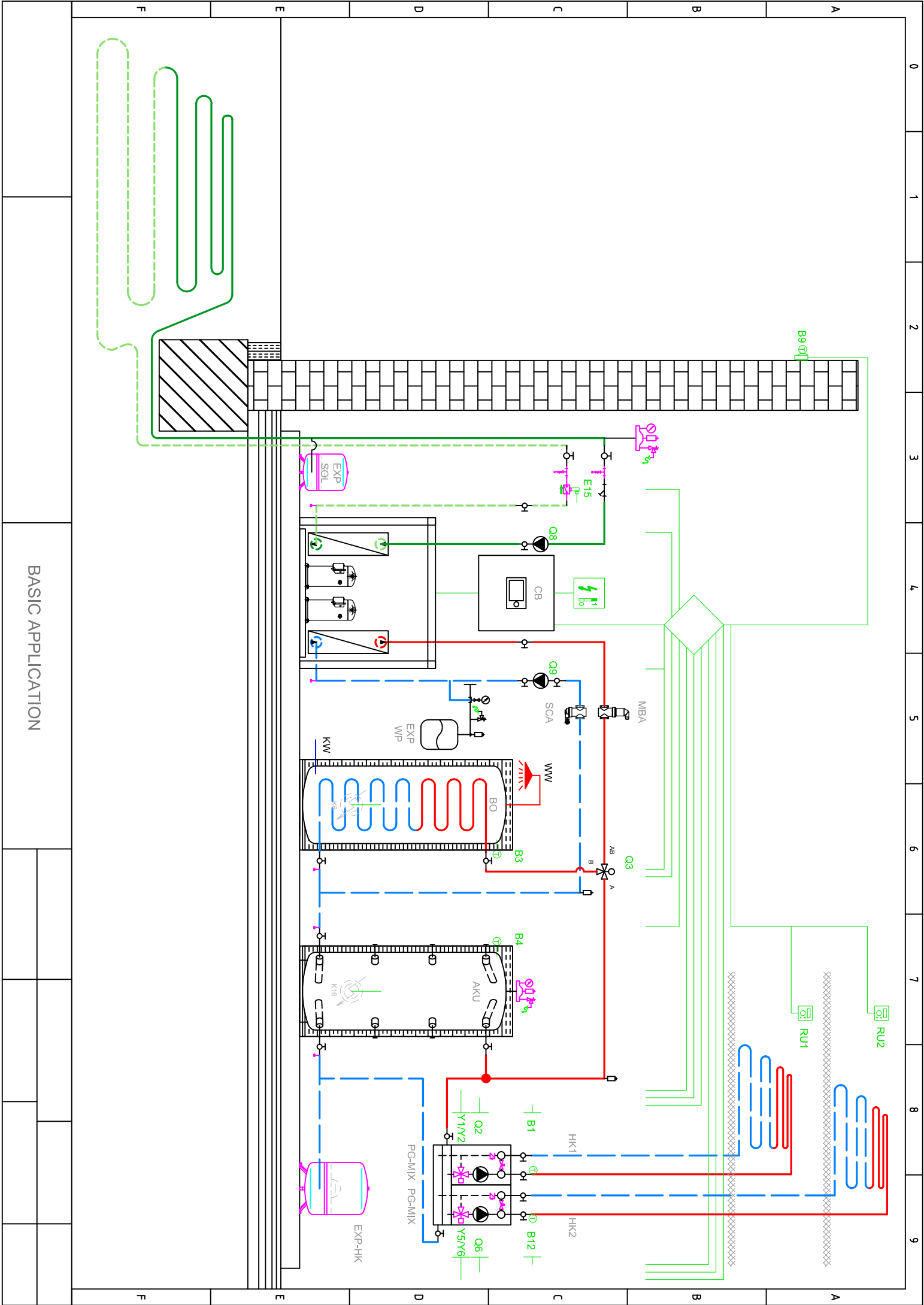

BASIC APPLICATION

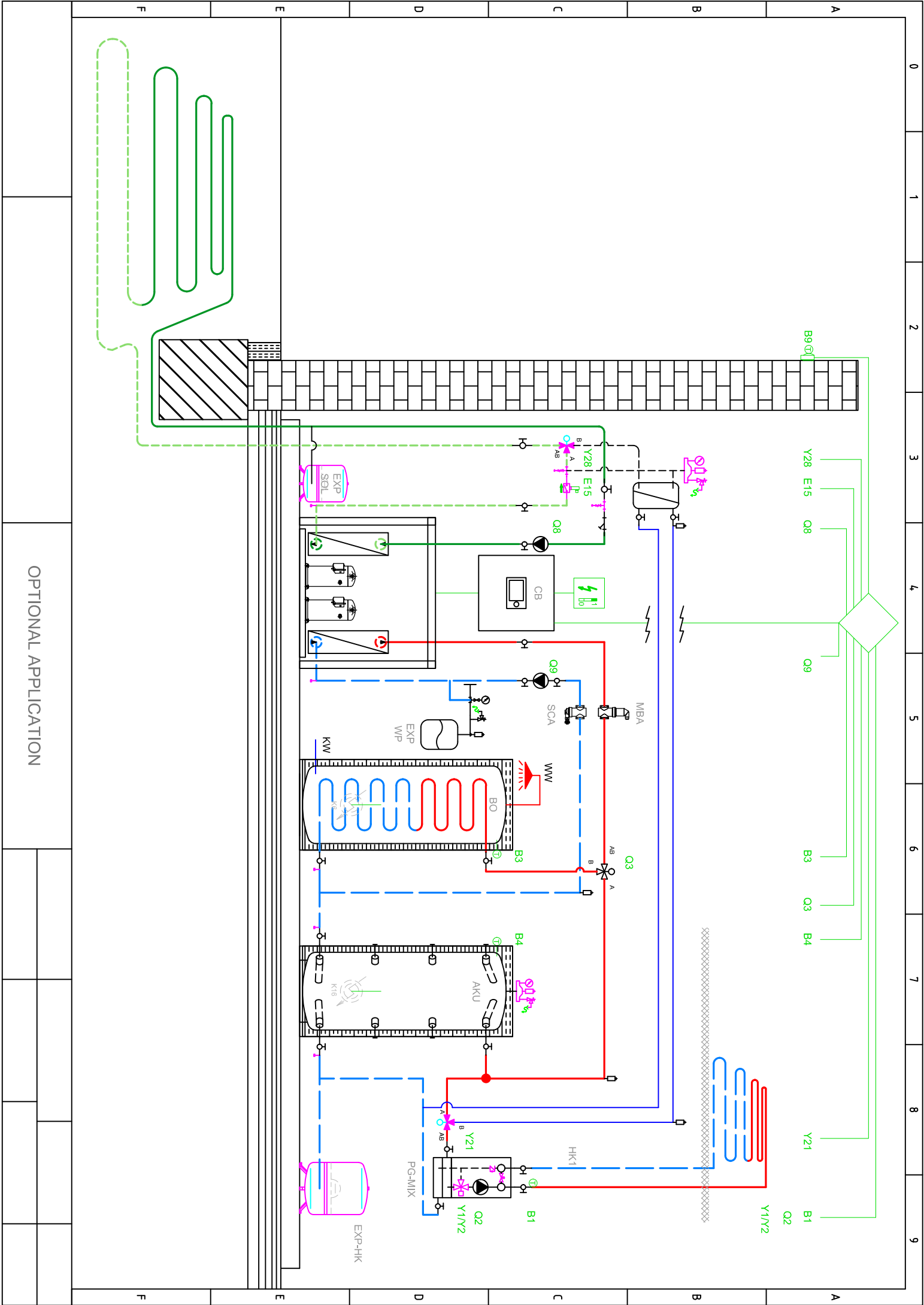

OPTIONAL APPLICATION

Total: max 6A
1 x QX...: max 2A

Netzanschluss 230V / 50 Hz
Erde
Nullleiter

- E9 Niederdruckwächter E9
- E10 Hochdruckwächter E10
- E15 Ström'wächter Quelle E15
- E24 Ström'wächter Verbrau E24
- E6 EW Sperre E6
- E12 Überlast Verdichter 2 E12
- E21 Drehstrom E21
- E22 Drehstrom E22
- E23 Drehstrom E23
- E11 Überlast Verdichter 1 E11
- K1 Verdichterstufe 1 K1

Q8 Quell'pumpe Q8

Q9 Kondensatorpumpe Q9

K10 Alarmausgang K10

K40 Ölumpfheizung K40

K81 Ventil Verdampfer K81

K82 Ventil EVI K82

K2 Verdichterstufe 2 K2

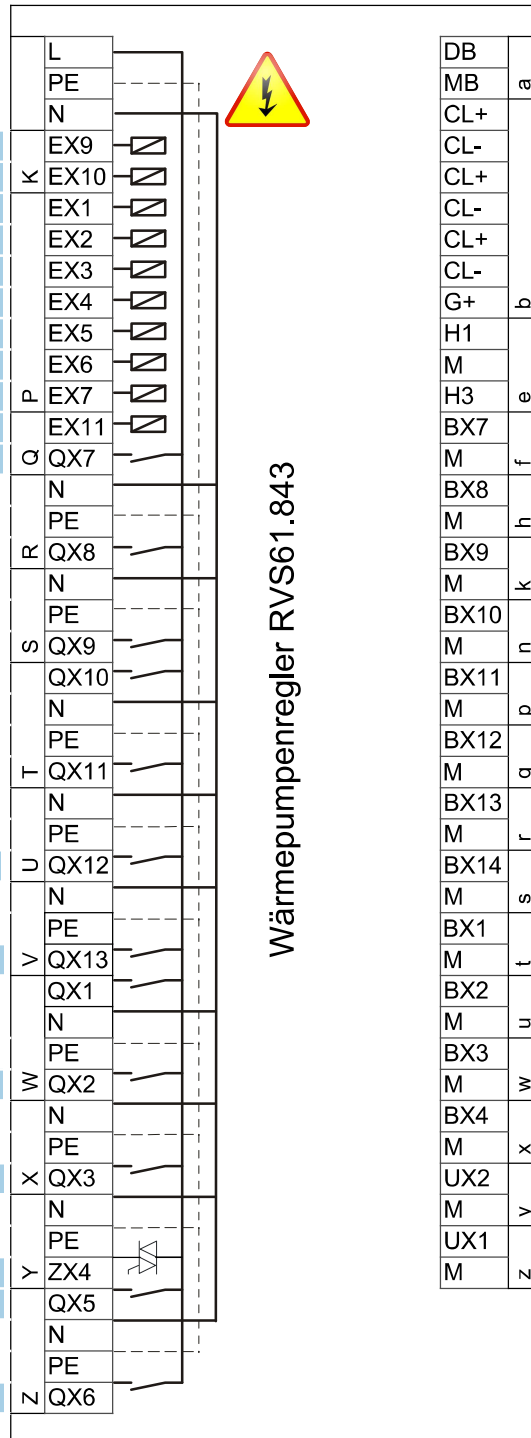

DB		LPB Bus Data
MB	a	LPB Bus Masse
CL+		Raumgerät QAA...
CL-		Raumgerät QAA... 2.
CL+		Raumgerät QAA... 2.
CL-		Raumgerät QAA... 2.
CL+		Raumgerät QAA... 3.
CL-		Raumgerät QAA... 3.
G+	b	12V Versorgung → AUS
H1		
M		
H3	e	Verbr'anforderung VK1
BX7		B81 Heissgasfühler K1 B81
M	f	
BX8		
M	h	
BX9		
M	k	B21 WP Vorlauffühler B21
BX10		
M	n	
BX11		
M	p	B71 WP Rücklauffühler B71
BX12		
M	q	B91 Quelleneintrittfühler B91
BX13		
M	r	B84 Quellenaust'fühler B92/B84
BX14		
M	s	
BX1		
M	t	
BX2		
M	u	B83 Kältemittelfühler flüssig B83
BX3		
M	w	B82 Heissgasfühler K2 B82
BX4		
M	x	Kondensatorpumpe Q9
UX2		0..10V Analogsignal
M	y	Quell'pumpe Q8
UX1		0..10V Analogsignal
M	z	



- AVS75.390
- AVS75.391
- AVS75.370

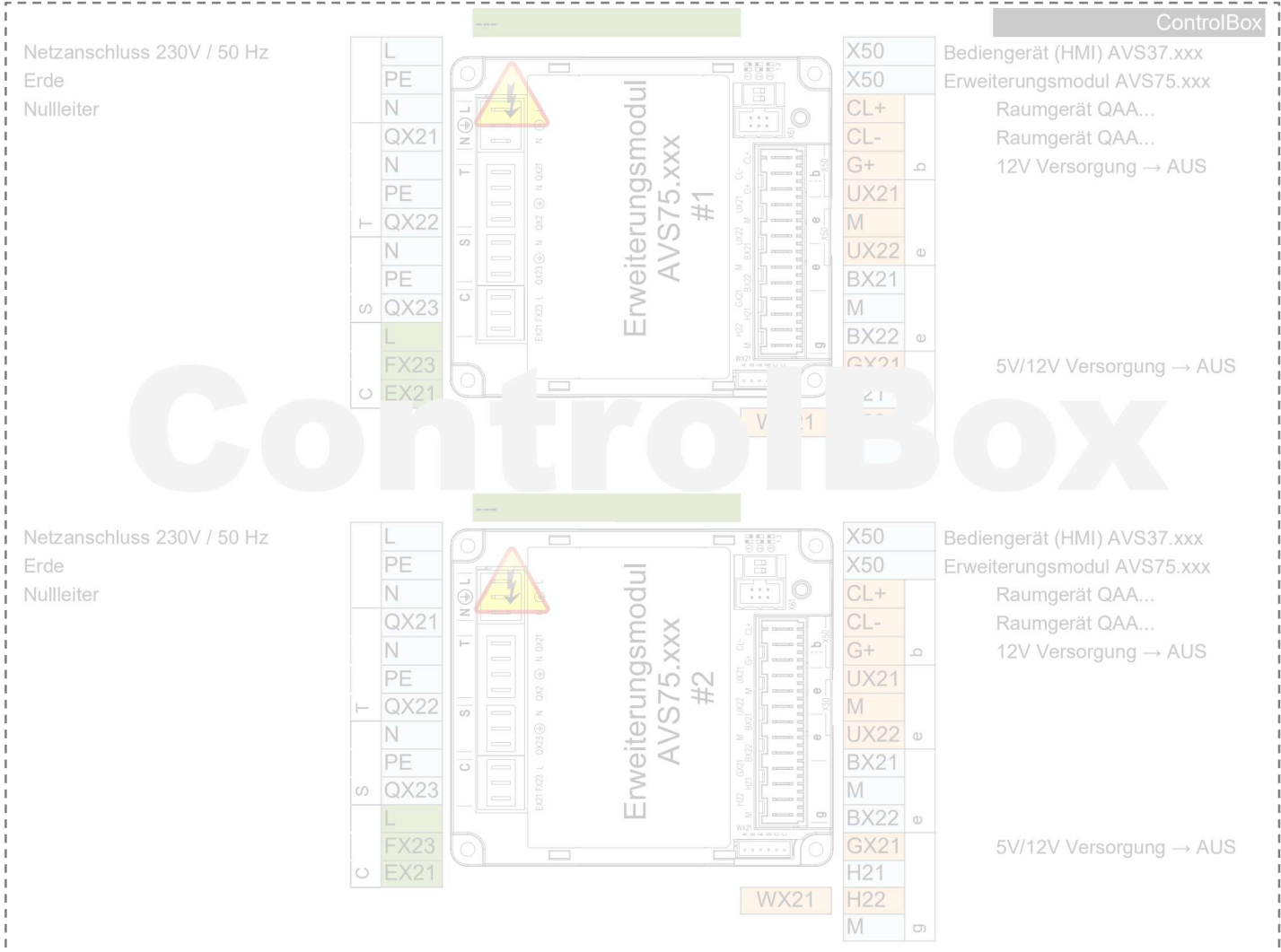

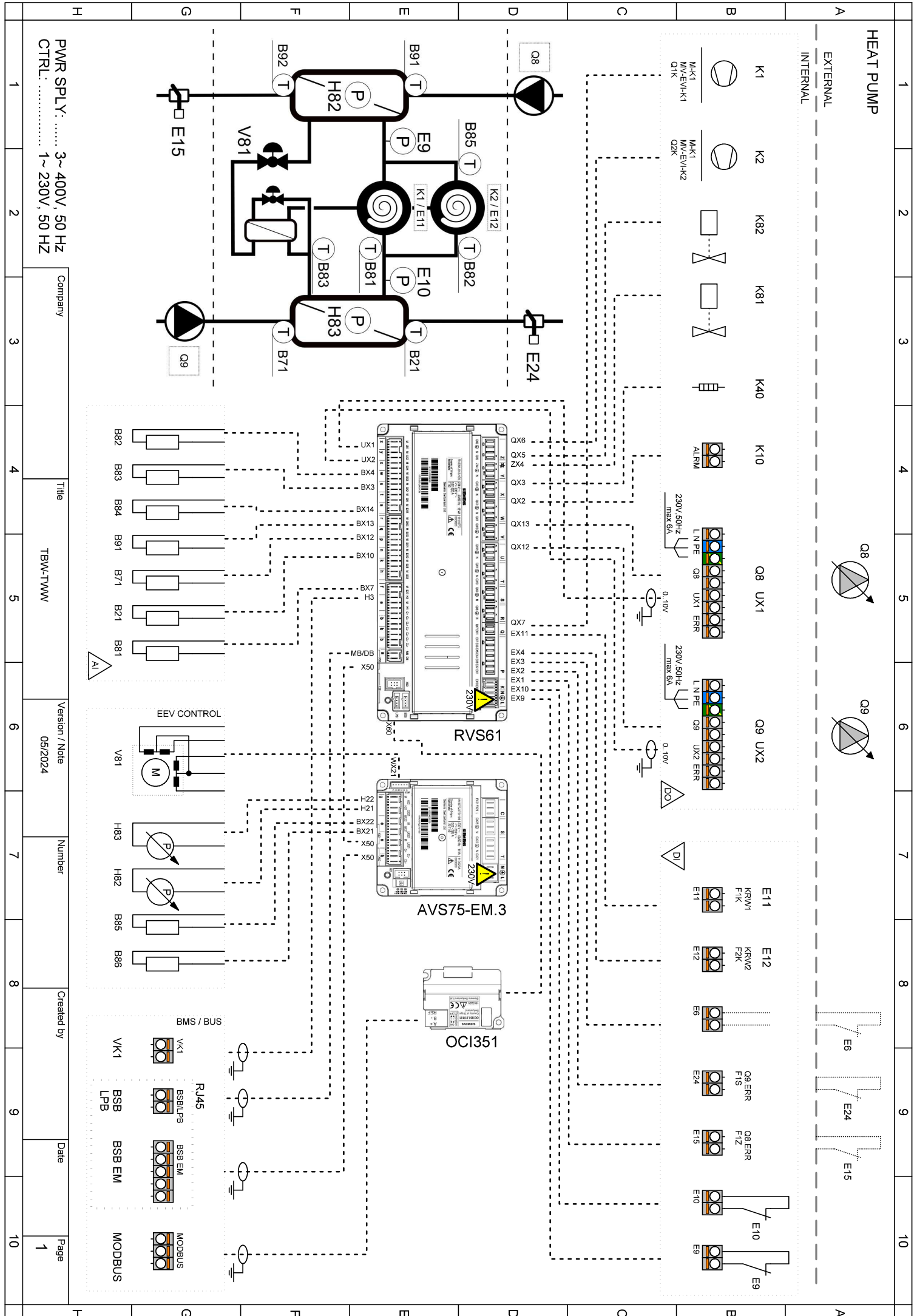

HEAT PUMP

EXTERNAL
INTERNAL

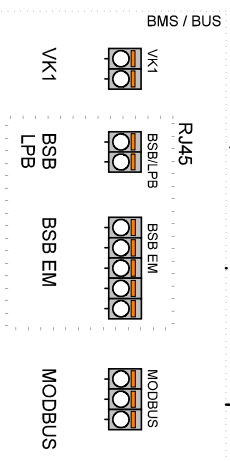
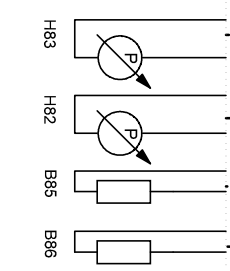
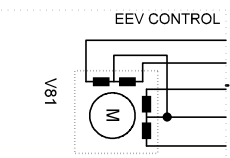
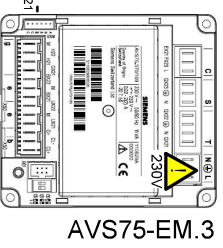
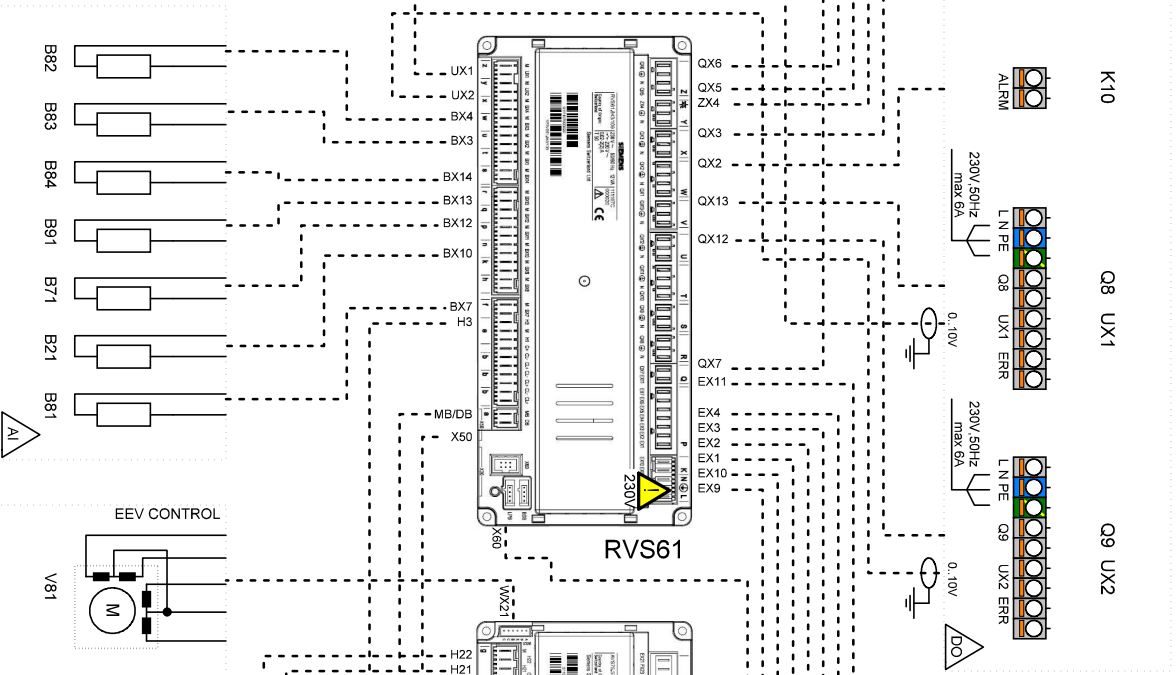
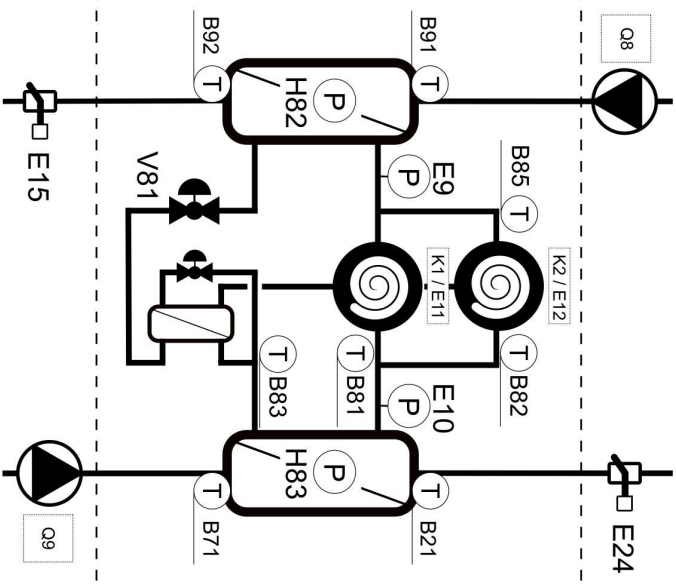
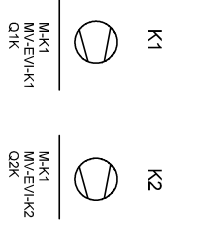

PWR SPLY: 3~ 400V, 50 Hz
CTRL: 1~ 230V, 50 Hz

Company	Title	Version / Note	Number	Created by	Date	Page
	TBW-TWW	05/2024				1

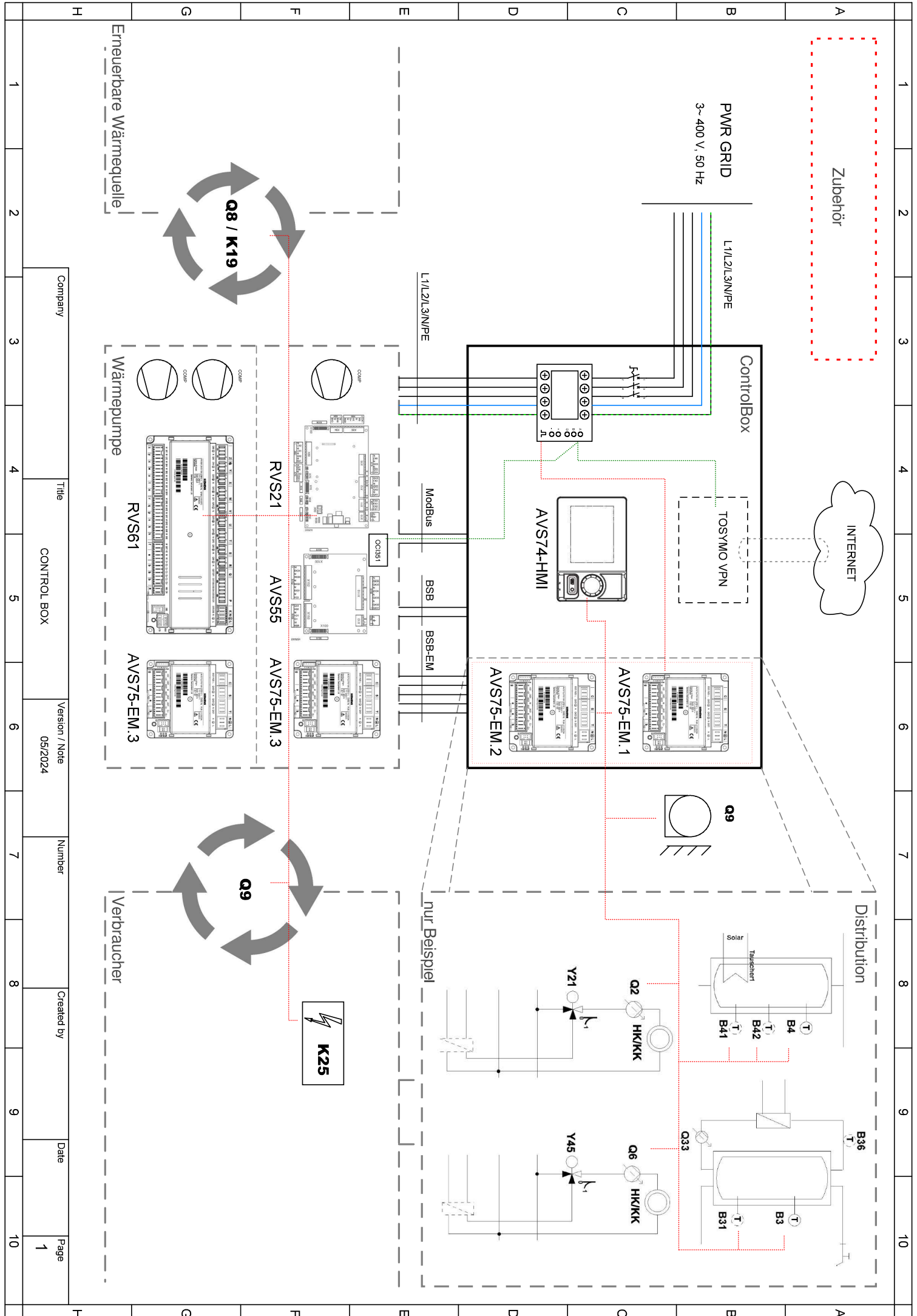

Zubehör



PWR GRID
3~400 V, 50 Hz

L1/L2/L3/N/PE

ControlBox

TOSYMO VPN

AVS74-HMI

AVS75-EM.1

AVS75-EM.2

Q9

Distribution

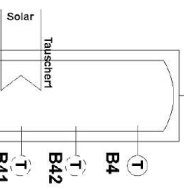

Q2

HK/KK

Y21

Q6

HK/KK

Y45

B36

T

B3

T

B31

T

Q33

nur Beispiel

K25

Q8 / K19

Erneuerbare Wärmequelle

Wärmepumpe

Verbraucher

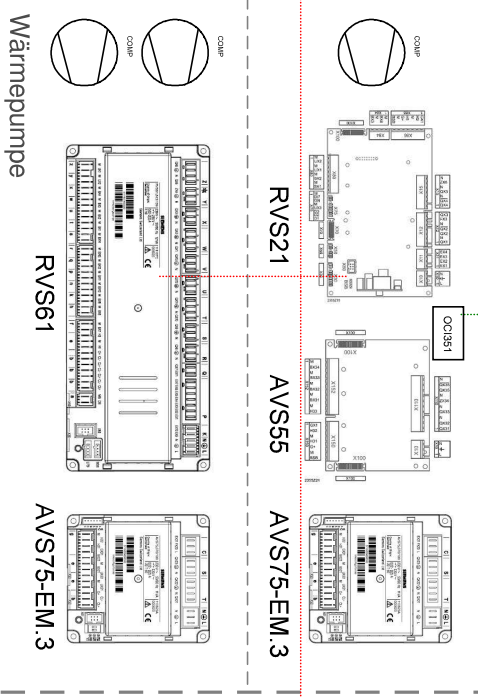

Company	Title	Version / Note	Number	Created by	Date	Page
	CONTROL BOX	05/2024				1

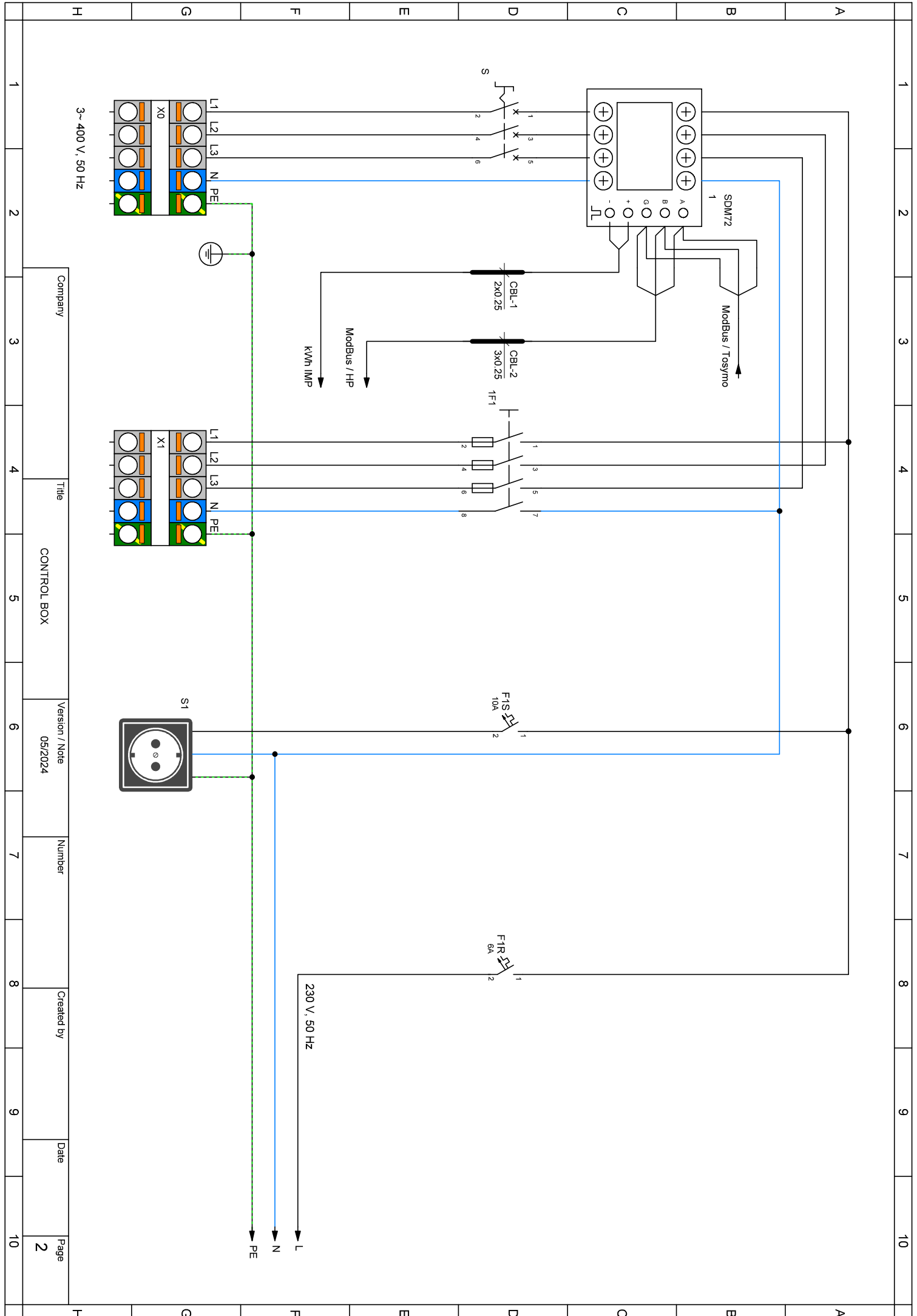

Company	Title	Version / Note	Number	Created by	Date	Page
	CONTROL BOX	05/2024				2

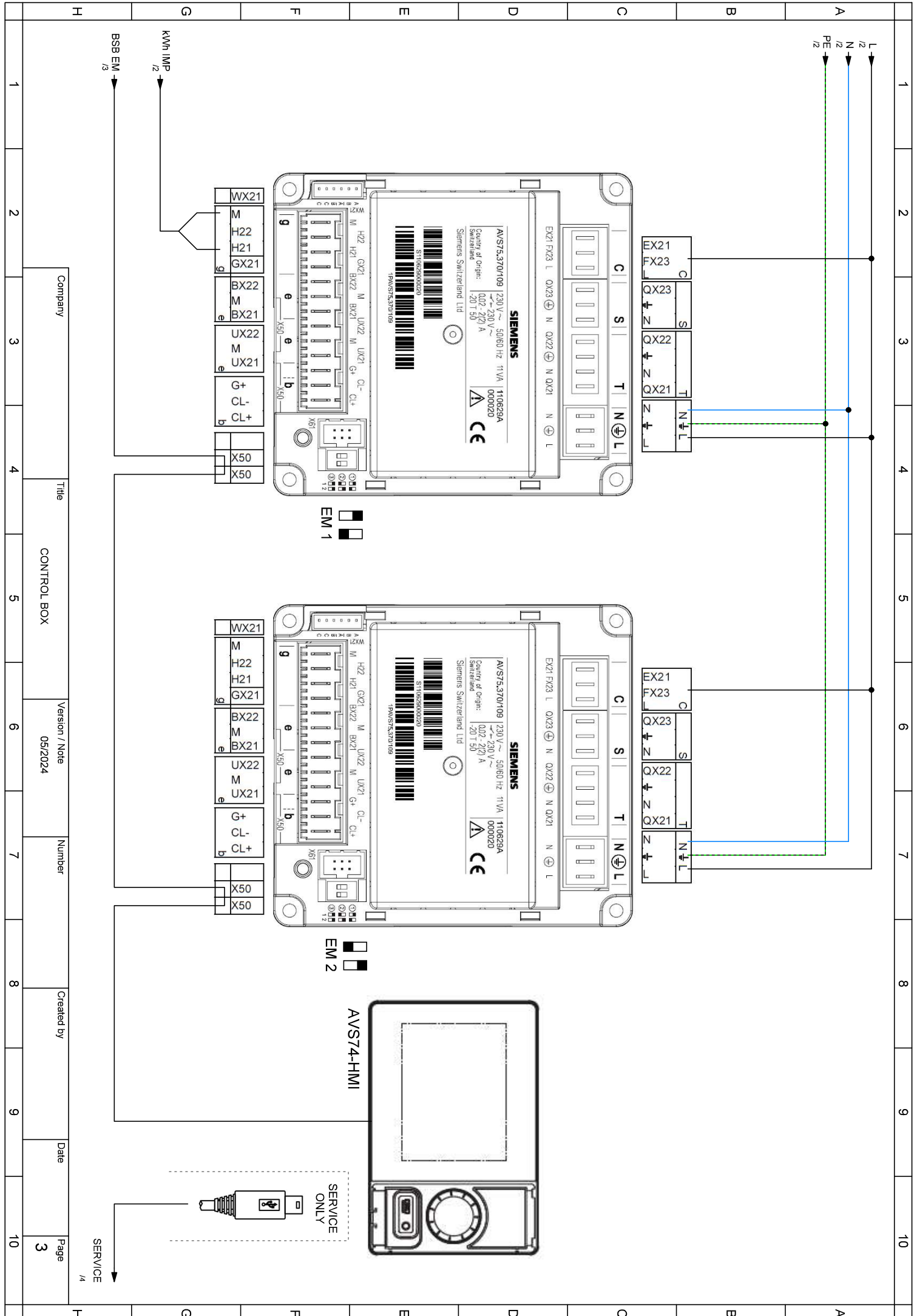

Company	Title	Version / Note	Number	Created by	Date	Page
	CONTROL BOX	05/2024				3

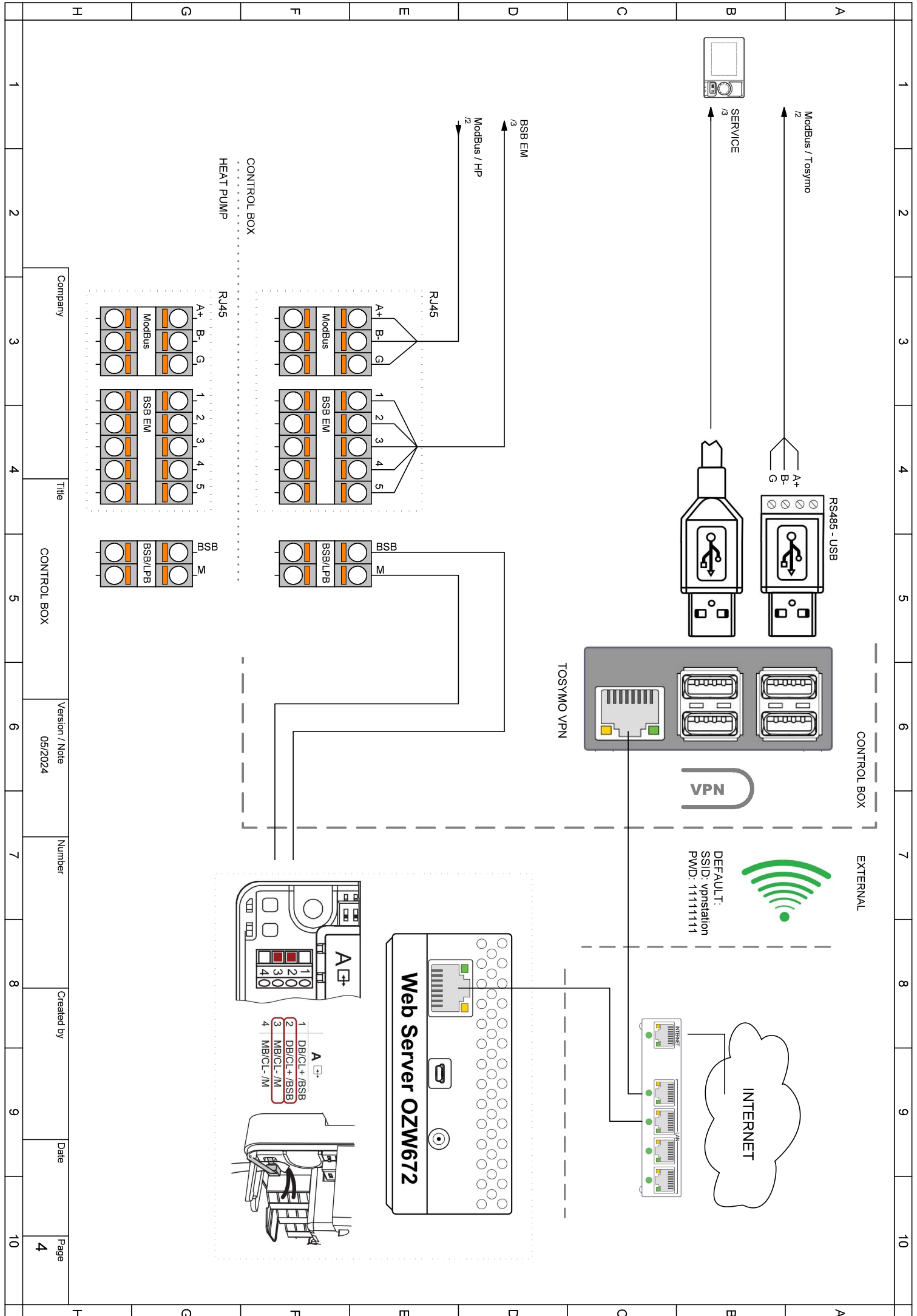

Company	Title	Version / Note	Number	Created by	Date	Page
CONTROL BOX	CONTROL BOX	05/2024				4



- AVS75.390
- AVS75.391
- AVS75.370

- AVS75.370**
 Netzanschluss 230V / 50 Hz
 Erde
 Nullleiter
Y1 Mischer Auf

Y2 Mischer Zu

Q2 Heizkreispumpe HK1 Q2

L Faze 230V
E61 Smart Grid E61

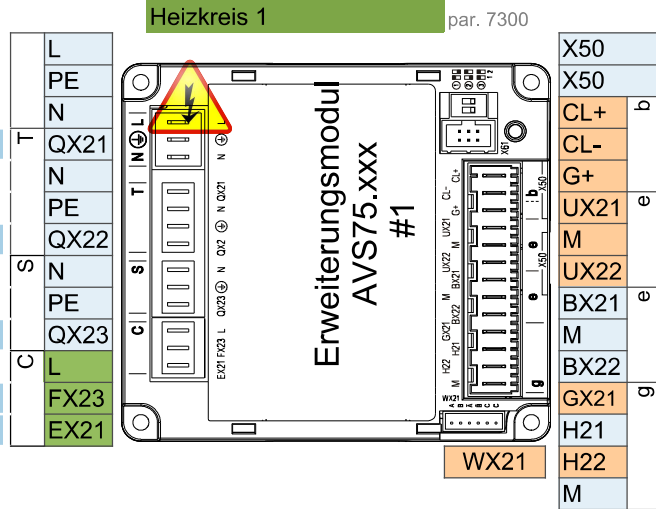

- Erweiterungsmodul AVS75.xxx
 Raumgerät QAA...
 Raumgerät QAA...

B1 Vorlauffühler 1

Impulszählung

- AVS75.370**
 Netzanschluss 230V / 50 Hz
 Erde
 Nullleiter
Q3 Trinkwasserstellglied Q3

K6 Elektroeinsatz TWW K6

Q6 Heizkreispumpe HK2 Q6

L Faze 230V
E62 Smart Grid E62

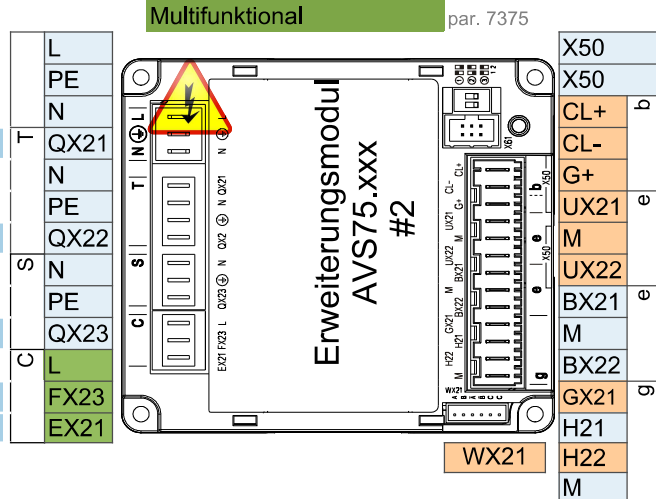

- Bediengerät (HMI) AVS37.xxx
 Erweiterungsmodul AVS75.xxx
 Raumgerät QAA...
 Raumgerät QAA...

B3 Trinkwasserfühler B3

B4 Pufferspeicherfühler B4

- Netzanschluss 230V / 50 Hz
 Erde
 Nullleiter

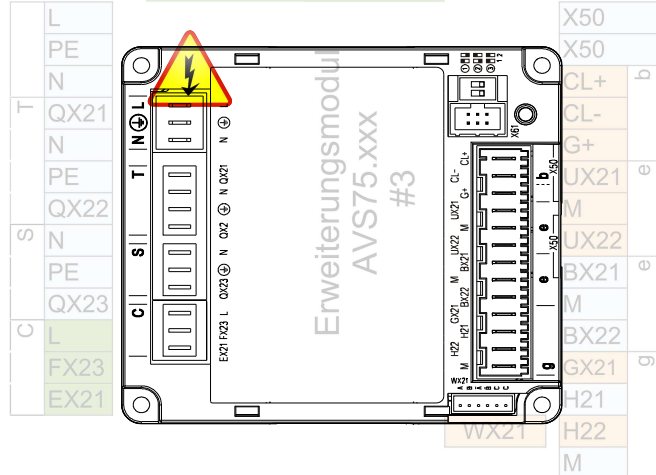

- Bediengerät (HMI) AVS37.xxx
 Erweiterungsmodul AVS75.xxx
 Raumgerät QAA...
 Raumgerät QAA...

Vorsicht: Erweiterungsmodul 3 ist in der Wärmepumpe

Anschlussmöglichkeiten für die Steuerung

1 ControlBox

ControlBox, mit zwei eingebauten Erweiterungsmodulen, ermöglicht zahlreiche Optionen für die Anwendungssteuerung auf der Verbraucherseite hinter der Wärmepumpe. Weitere Informationen finden Sie im Schaltplan der ControlBox und im Blatt mit den Anwendungsdiagrammen.

2 Fixer Sollwert Vorlauftemperatur - Ein / Aus potentialfreier Kontakt

2-adriges abgeschirmtes Kabel 2 x 0,5 mm² - Sollwert = 45°C (editierbar über Parameter 1859)

Anschlussklemme - siehe Schaltplan

3 Analog 0..10V Vorlauftemperatur-Sollwertregelung

2 Adern geschirmtes Kabel 2 x 0,5 mm² - Sollwert: 0V = 16°C ~ 10V = 60°C (editierbar im Parametersatz)

Anschlussklemme - siehe Schaltplan

4 ModBus RTU-Kommunikationsbefehl

3-adriges abgeschirmtes Kabel min. 3 x 0,25mm²

Für die ModBus-Zuordnungstabelle wenden Sie sich bitte an den technischen Support

5 MQTT IoT-Kommunikationsprotokoll

Für weitere Informationen wenden Sie sich bitte an den technischen Support